

TECHNICAL & ESD FURNITURE  
ANTISTATIC EQUIPMENT  
DRY STORAGE CABINETS



**VIKING**



Authorised Agent



**Viking Equipment** has implemented dozens of equipping projects for such companies like Samsung Electronics, LG Electronics, Volkswagen Group, Nissan Manufacturing, Elcoteq, TPV Technology, and Foxconn.

**VIKING** ESD and technical furniture manufacturing site is located near Saint Petersburg and occupies the territory of over 6.000 square meters. We constantly monitor manufacturing process and quality of our products on all stages, which is acknowledged by ISO 9001:2015 quality management systems certificate. Being a member of IEC committee for ESD, we adjust engineering and manufacturing processes according to latest requirements of IEC 61340 standard.

## VIKING TECHNICAL AND ESD FURNITURE

**Today** VIKING technical and ESD furniture brand offers a wide range of different modular workstations, ESD storage and transportation furnishing solutions, and a range of antistatic equipment.

VIKING technical furniture is distinguished by:

- Wide range of functional, convertible and interchangeable modules for each particular employee;
- Adjustment, layout and customization according to clients' specific needs;
- Possibility of modernization and refitting after the purchase;
- Strict compliance with the international antistatic standard IEC 61340.

## VKG TOOLS ESD EQUIPMENT

**Besides** a broad line of furniture, we offer a range of antistatic products and consumables to fully equip ESD-protected areas. Among them, one can find garments, storage and transportation means, monitoring and audit devices. These products are sold under VKG TOOLS brand.

**This catalog is informational. Minor amendments/changes in products exterior, composition and technical characteristics are permitted. Graphic images of the units are schematic and should not be perceived as engineering drawings.**

## TABLE OF CONTENT

VIKING technical furniture Configurator _____	4
3D online workspace Planner _____	5
Our customers _____	6
Technical&ESD furniture _____	8
- VIKING workplaces series _____	9
- ALPHA series workbenches _____	10
- ALLIANCE series workbenches _____	12
- ALLIANCE automatic workbenches _____	14
- SIGMA Electric Workbench _____	16
- GAMMA series workbenches _____	18
- CLASSIC series workbenches _____	20
- COMFORT series workbenches _____	22
- CONSTANT series workbenches _____	24
- OSTROV series workbenches _____	26
- VERSTAK series technical workbenches _____	28
- VERSTAK GRAND heavy-duty workbenches _____	30
- TITAN series heavy duty technical workbenches _____	32
- Specialized workbenches _____	36
- Specialized workbenches for optical fiber handling _____	36
- Wire harness workbench _____	38
- Wire harness workbench accessories _____	39
- Packing workstation _____	40
- Customized layouts _____	42
- Workplaces additional equipment _____	44
- Drawer units _____	48
- Movable tables and carts _____	53
- Movable trolleys _____	56
- Cabinets and wardrobes _____	58
- Shelvings _____	61
- Modular counters _____	62
- Dry storage cabinets _____	64
- ESD chairs _____	70
VKG tools antistatic equipment _____	73
- VKG A-2000 turnstile access control system to ESD Protected Area _____	73
- Grounding equipment _____	74
- Purex Fume extraction systems _____	76
- ESD storage and packaging _____	78
Catalog legend _____	81

# VIKING TECHNICAL FURNITURE CONFIGURATOR



Most VIKING technical and ESD workbenches consist of functional and interchangeable modules to provide maximum flexibility in creating customized workstations, which satisfy any specific working process requirements. It may become an uneasy process to make a choice of elements guided solely by modules' description and codes and thus assemble certain set. With our online service — VIKING technical and ESD furniture Configurator (<https://viking-esd.com/constructor>), any user is interactively guided along the process of workbench assembling. Thus, it is much easier to make the right choice.

VIKING technical and ESD furniture Configurator helps to choose necessary basic modules and additional units of a required workstation online. It simplifies the process of assembling a workbench set, saves time and helps to avoid possible mistakes in modules compatibility. While assembling a workbench in online configuration tool one also chooses version (technical or ESD) and color (light gray RAL 7035 or dark gray RAL 7012) where applicable.

After choosing required options and elements one can place an order for chosen set to any VIKING official distributor online, print the individual set or use the picture and the list of modules for future orders.

VIKING technical furniture Configurator is also useful for workstations future amendments. Any time after the purchase customer can add or change certain modules of a workstation so that it meets new requirements of the manufacturing process.

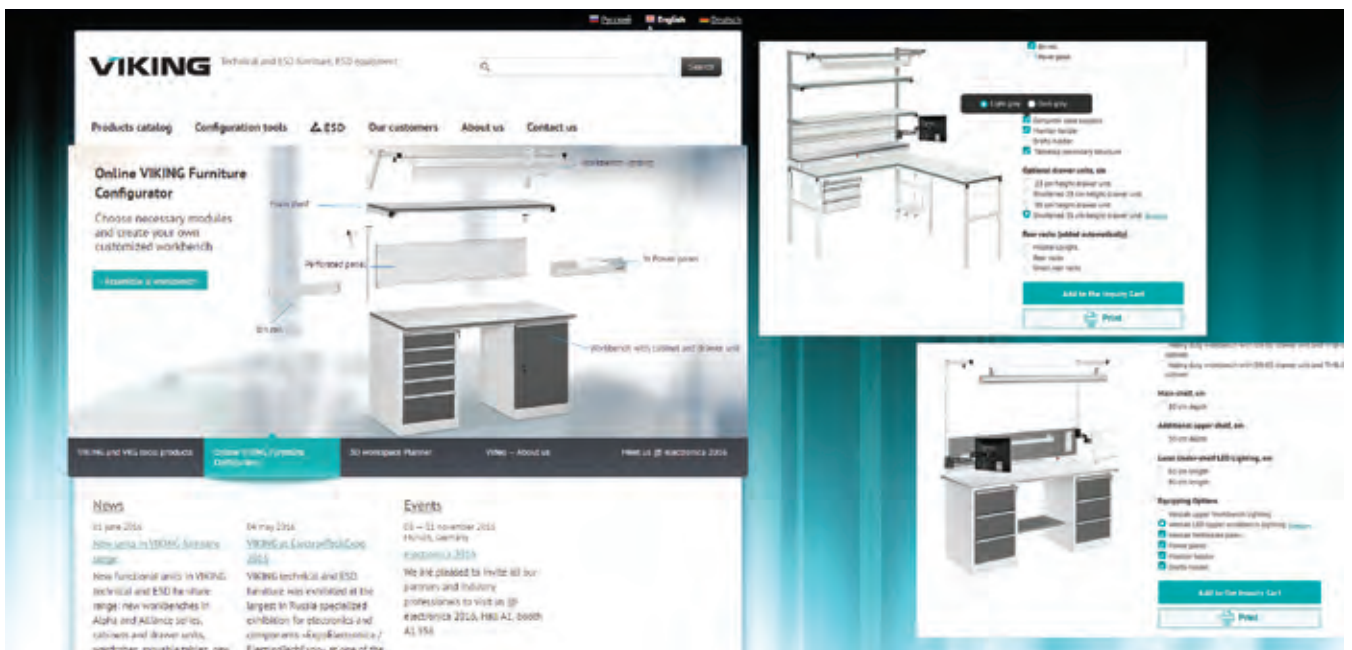

# 3D ONLINE WORKSPACE PLANNER

The 3D online workspace planner software is used for manufacturing space retrofitting planning, design and visualization; it provides the possibility of trying on several options of the entire production area equipment with VIKING furniture and additional elements.

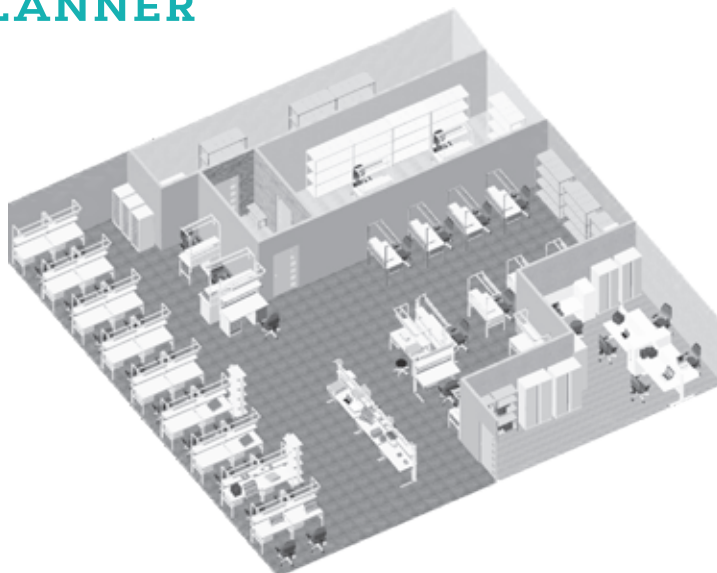

**While** being on the stage of planning new manufacturing facilities, workspace refurbishing or re-equipping it is very useful to have the ability to compare different types of furniture and equipment layouts. Using the exact halls dimensions, 3D Planner software user can build up a 3D plan of the hall, estimate the quantity of necessary technical furniture and it's disposition, arrange workplaces, passageways and utility premises. Our online 3D workspace Planner allows to specify windows, doors, columns' sizes and positions, and to choose colors and shapes of additional elements.

**Online** software is free for any visitor of <https://viking-esd.com>, one just needs to install a plug-in to their device.

**Using** 3D workspace planner software its user gets a visual plan of re-equipped halls in isometric, top and 3D front view and detailed list of chosen furniture and equipment. All images can be saved in standard .jpg format to be sent, viewed or printed or in specific .o3d format to continue the work later.

# OUR CUSTOMERS





# TECHNICAL & ESD FURNITURE

ALPHA, ALPHA universal



ALLIANCE, ALLIANCE automatic



GAMMA



CLASSIC



COMFORT



CONSTANT



OSTROV



SIGMA Electric



PACKING Workstation



VERSTAK Grand



VERSTAK



TITAN



Wire harness workbench



SPECIALIZED



UNIVERSAL





## VIKING WORKPLACES SERIES

Most of VIKING products are available in technical and ESD (antistatic) versions, the latter are marked with ESD label.

Steel frames are powder-coated in dark grey (RAL 7012) or light grey (RAL 7035) color, tabletops are resistant to abrasion. Some VIKING workbenches also have black (RAL 9005), white (RAL 9010) and turquoise (RAL 5021) parts. VIKING workbenches are modular, allowing customers to order only necessary parts and get workplaces for any specific use.

Viking workbenches can be equipped with standard and LED upper workbench lighting units.

Sets of furniture can be supplemented by additional equipment at any time after the purchase. Assembly and installation is quick and simple, clear assembly instructions are provided with each module, they are also available for download from <https://viking-esd.com>. VIKING ESD-protected products are compliant with IEC 61340 standard, have corresponding certificates and test reports.

VIKING workbenches product range includes a wide line of functional, convertible and interchangeable modules for each particular enterprise. To facilitate configuration and simplify different elements choosing, our customers are welcome to use CONFIGURATOR (<https://viking-esd.com/constructor>), our online service that helps to interactively select all necessary workbench parts. After choosing required options and elements, one can print the individual set and use the picture and the list of modules for future orders.



We divide our workbenches and supplementary elements in several series, each has its own peculiarities:

- **ALPHA** series workbenches allow effective use of space, offer practical structures and a compact size;
- **ALPHA Universal and ALPHA T** are simplified ALPHA workbenches without possibility of upper extensions;
- **ALLIANCE** workbenches are distinguished by elegant design, advanced ergonomics and convenient system of height adjustment. They can be placed in an inseparable line where each two tabletops are held by lateral frames and share those in the middle. Also available in double-sided version;
- **ALLIANCE Automatic** with motorized worktop adjustment system, performed by electric drive and simple control unit;
- **GAMMA SERIES** is based on the concept of clear surfaces, where all technical communications are hidden and the fasteners organically fit the design;
- **CLASSIC** workplaces are simple, functional and inexpensive. They can be placed in a line with no gaps for conveyor work;
- **COMFORT** workbenches are based on L-shape steel supports and offer advanced ergonomics for comfortable work;
- **CONSTANT** workbenches with fixed worktop height are equipped with functional supports and can withstand an increased load;
- **OSTROV** double-sided workbenches are designed for the most effective use of workspace;
- **SIGMA Electric** workbenches are electrically height adjustable workspaces, supporting any ergonomic requirements of each user.
- **PACKING Workstation** - adjustable ergonomic workstation that helps to easily access all packaging materials - cartons, tape, paper, bubble wrap or others.
- **VERSTAK Grand** heavy-duty workbenches designed to work in a standing position and feature reinforced structure that can withstand a distributed load of up to 2000 kg.
- **VERSTAK** workbenches are available only in non-antistatic version, but their rigidity and different tabletop and support types will be useful for manufacturing process;
- **TITAN** heavy duty workbenches with up to 2000 kg load capacity and enhanced tabletops;
- **Wire harness workbench** with 0° to 80° angle adjustable worktop, which allows fastening various types of wires and bundles;
- **SPECIALIZED** workbenches were made to satisfy specific working process requirements;
- **UNIVERSAL** workbenches, the simplest and cheapest ones, they do not allow any above tabletop extensions.

In addition, we can always manufacture customized products and are confident of our ability to satisfy and meet our customer's individual requirements.

# ALPHA SERIES WORKBENCHES

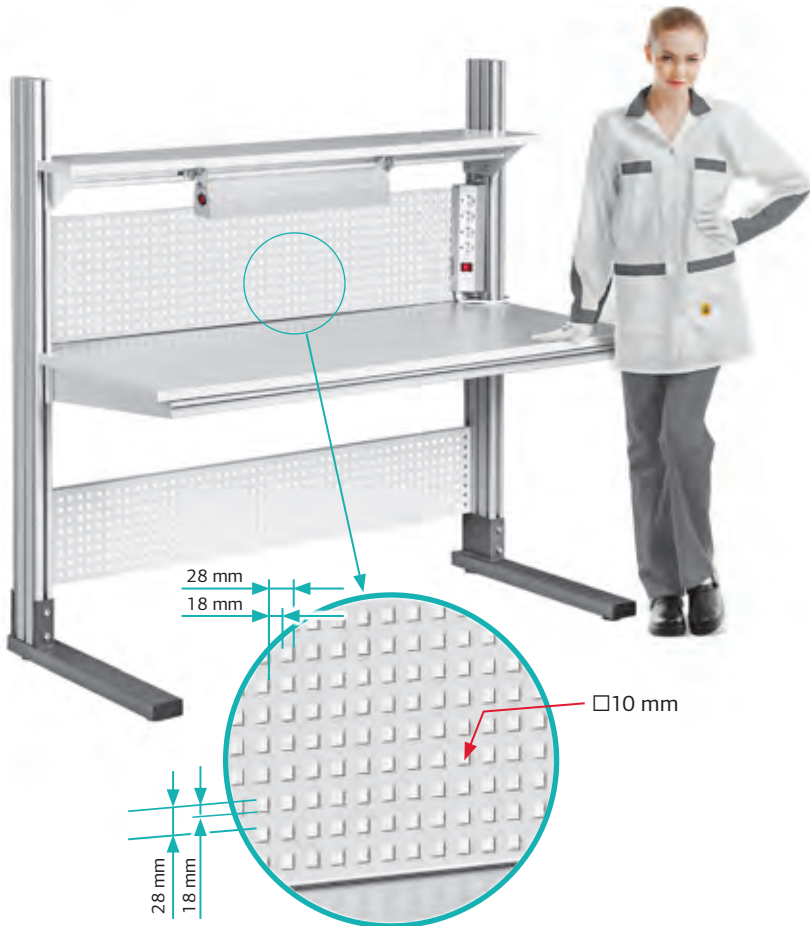

ALPHA series workbenches with lateral aluminum frames are stylish and ergonomic workbenches that can perfectly equip unspecified technical premises and educational facilities. Alpha series workbenches are distinguished by practical modular construction and compact size; they allow effective use of hall space. We offer four models of ALPHA series workbenches: single workbench, double workbench, simplified universal workbench, T-shape simplified workbench. Tabletop thickness 25 mm.





All ALPHA series workbenches are bicolored by default. When ordering, please mention whether ESD or technical version required.

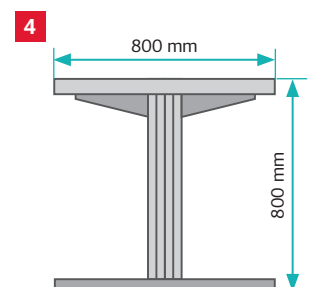
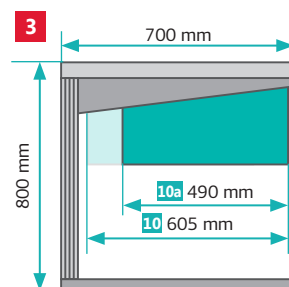
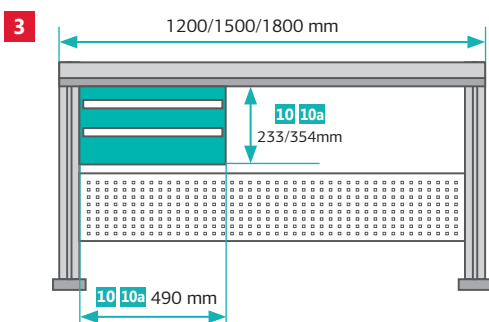
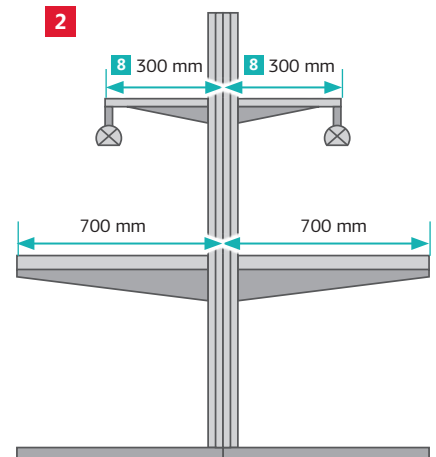
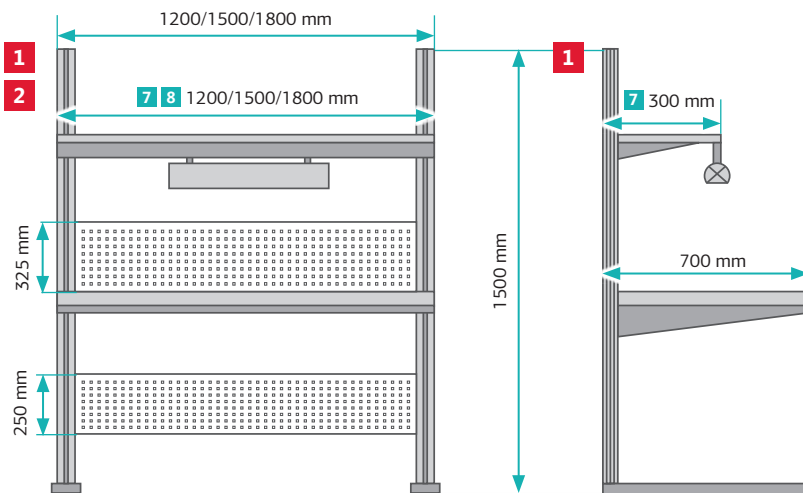

For this catalog legend, please see p. 81

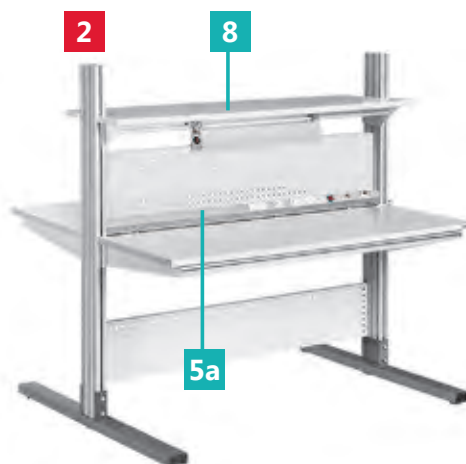
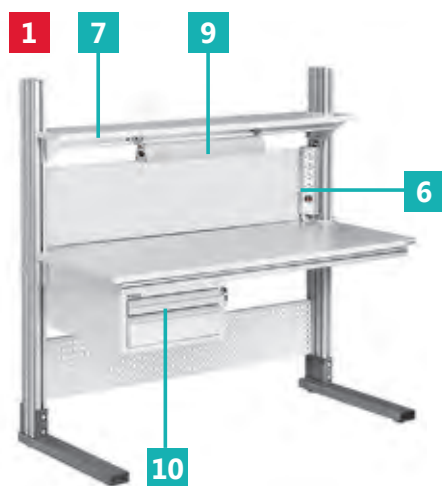



**1** ALPHA Single workbench   

Single workbench with lateral aluminum frames is supplied in a set with two perforated panels.

 600-1100 mm



 200 kg  300 °C

**2** ALPHA Double workbench   

Double-sided workbench with lateral aluminum frames is supplied in a set with two double perforated panels and two tabletops.

 600-1100 mm  per tabletop 200 kg

 300 °C

**3** ALPHA Alpha universal workbench   



Simplified Alpha series workbench without upper modules.

 See more on p. 36.

**4** ALPHA T-shaped workbench   

Simplified Alpha series T-shaped workbench without the possibility of additional extensions.

 200 kg  300 °C



**5** ALF-EPA Power panel /  
**5a** ALF-O-EPA Double power panel  

An aluminum case/ two cases with four sockets, protective contact, switch and 3 m cable. Can be equipped with additional sockets, fuses, phone jacks and earth leakage circuit breakers.

- Nominal load capacity: 10 A

**6** ALF-EPA/B Side power panel  



Four sockets with protective contact and 3 m cable in a small aluminum case. Side power panel can be mounted on any part of lateral aluminum frame. No extension is possible.

**7** ALF-PO Main shelf   

Main shelf for Alpha series single workbenches.

 1200-1500 mm

 50 kg

**8** ALF-O-PO Double main shelf   

Main shelf for Alpha series double workbenches.

 1200-1500 mm

 each side 50 kg





**9** DL/N2 Under-shelf local LED lighting  





Additional lighting can be mounted under the main shelf or attached to perforated panel. Suitable for any workbench equipped with upper modules. Angle adjustment 80°.

- 2 versions: 60 cm length and 90 cm length

- Color temperature 4700–5300 K

Provides at least 1000-lux illuminance at 1000 mm distance from the light source. Also available with dimmer. See more on p. 46.

**10** Optional drawer units/    

**10a** Optional drawer units with reduced depth    

Storage solution for tools and components, no place on floor required. Those with reduced to 490 mm depth allow installing various additional equipment under a tabletop.

 See more on p. 48

# ALLIANCE SERIES WORKBENCHES



ALLIANCE workbenches are distinguished by elegant design, advanced ergonomics and convenient system of height adjustment.

We also offer motorized worktop adjustment materialised in Alliance Automatic series workbenches AL-A.  See more on p. 15.

Several Alliance workbenches can be placed in an inseparable line where two tabletops are held by side lateral frames and share those in the middle.

**Standard** Alliance workbenches are powder-coated in dark grey color (RAL 7012) for lower steel modules and light grey color (RAL 7035) for tabletops and shelves. Possible tabletop height adjustment: 600–1300 mm. Possible lighting height adjustment: 1200–2000 mm. Maximum height of lighting ramp - 2090 mm.

Tabletop thickness 25 mm.

All ALLIANCE series workbenches are bicolored by default. When ordering, please mention whether ESD or technical version required.

For this catalog legend, please see p. 81

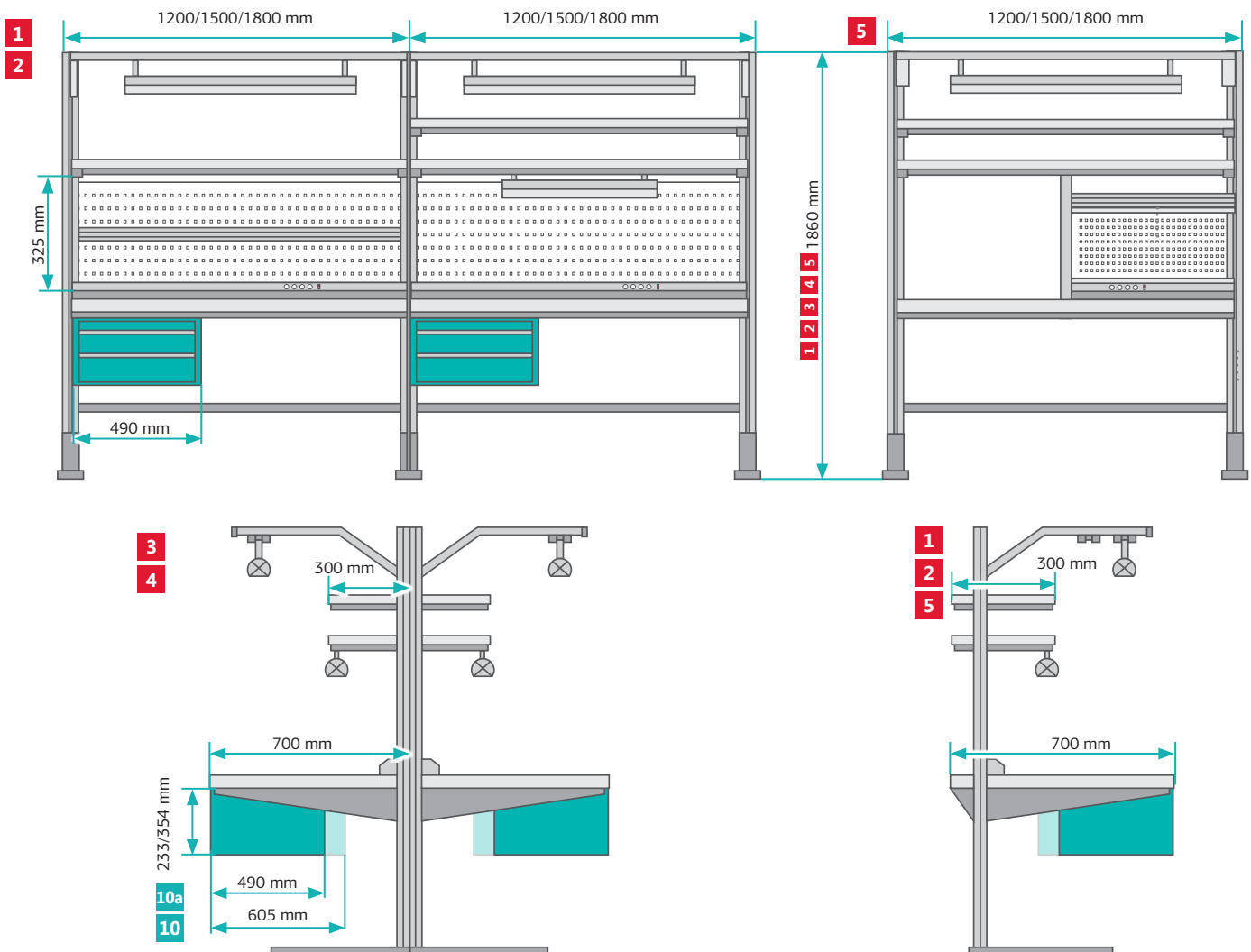

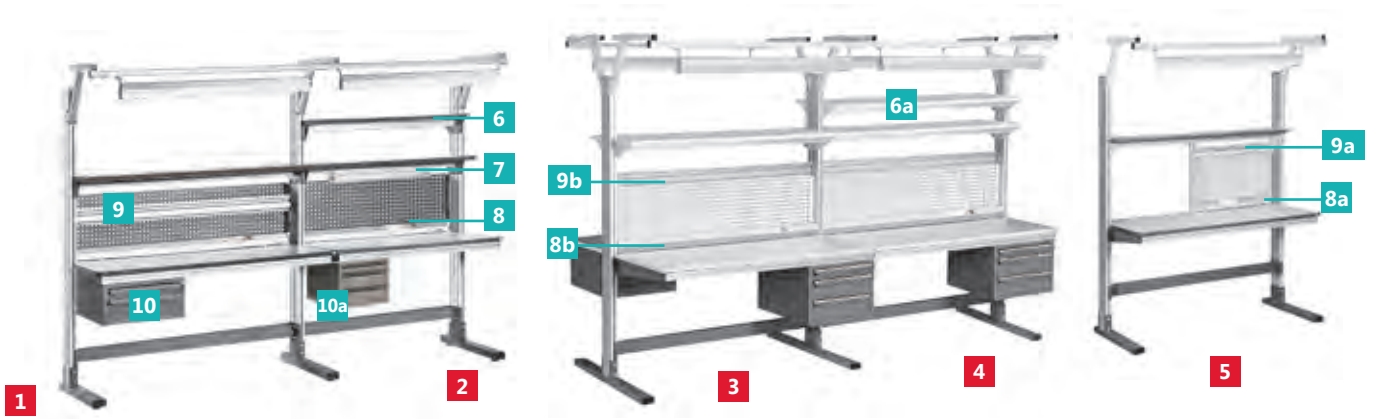

**1** Alliance set /  
Alliance set with LED lamp

Single workbench with two lateral aluminum frames. The workbench is supplied in a set with lower slat, perforated panel, main shelf and lighting. AL-S2 Alliance sets are supplied with upper LED lighting.

200 kg

**2** Alliance additional set /  
Alliance additional set with LED lamp

Additional set with one lateral aluminum frame is meant to be attached to main Alliance workbench from either side, which provides inseparable working surface line. The set includes: workbench with one lateral frame, lower slat, perforated panel, main shelf and lighting. AL/D-S2 Alliance additional sets are supplied with upper LED lighting.

200 kg

**3** Alliance double set /  
Alliance double set with LED lamp

Double side workbench with two lateral aluminum frames. The workbench is supplied in a set with double lower slat, double-sided perforated panel, double main shelf and two lighting units. AL-O-S2 Alliance double sets are supplied with two upper LED lighting units.

each tabletop

200 kg

**4** Alliance additional double set /  
Alliance additional double set with LED lamp

Double side workbench with one lateral aluminum frame to be attached to main Alliance double workbench. The workbench is supplied in a set with double lower slat, double-sided perforated panel, double main shelf and two lighting units. AL-O-S2 Alliance additional double sets are supplied with two upper LED lighting units.

each tabletop 200 kg

**5** Alliance set/  
Alliance set with LED lamp

Single workbench with two lateral aluminum frames. The workbench is supplied in a set with middle upright, half-size perforated panel, lower slat, main shelf and lighting. AL-SRST-S2 Alliance sets are supplied with upper LED lighting.

each tabletop 200 kg

**6** AL-PO/1 Additional shelf /

**6a** AL-O-PO/1 Additional double shelf

1000-1850 mm 100 kg

**7** DL/N Under-shelf local LED lighting

Additional lighting can be mounted under the main shelf or attached to perforated panel. Suitable for any workbench equipped with upper modules. Angle adjustment 80°

- 2 versions: 60 cm length and 90 cm length.
- Color temperature 4700-5300 K
- Provides at least 1000-lux illuminance at 1000 mm distance from the light source.

**8** AL-EP Power panel

**8a** ½ AL-EP Power panel

**8b** AL-O-EP Double power panel

An aluminum case/ two cases with four sockets, protective contact, switch and 3 m cable. Can be equipped with additional sockets, fuses, phone jacks and earth leakage circuit breakers.

- Nominal load capacity: 10 A

**9** AL-RK Bin rail

**9a** ½ AL-RK Bin rail

**9b** AL-O-RK Double bin rail

Aluminum rail for bin storage placed along workbench length.

AL-RK 1147/1447/1747×100 mm 10 kg

½ AL-RK 547/697/847×100 mm

AL-O-RK 2×(1147/1447/1747)×100 mm

**10** Optional drawer units/

**10** Optional drawer units with reduced depth

Storage solution for tools and components, no place on floor required. Those with reduced to 490 mm depth allows installing various additional equipment under a tabletop.

See more on p. 48

**11** AL-IP Cantilever

It was designed for easy-to-reach attaching of drawings, lighting and instruments. IP Cantilever can be additionally equipped by retracting KL-1200 mechanism.

ALL LED lighting also available with dimmer. See more on p. 46

# ALLIANCE AUTOMATIC WORKBENCHES





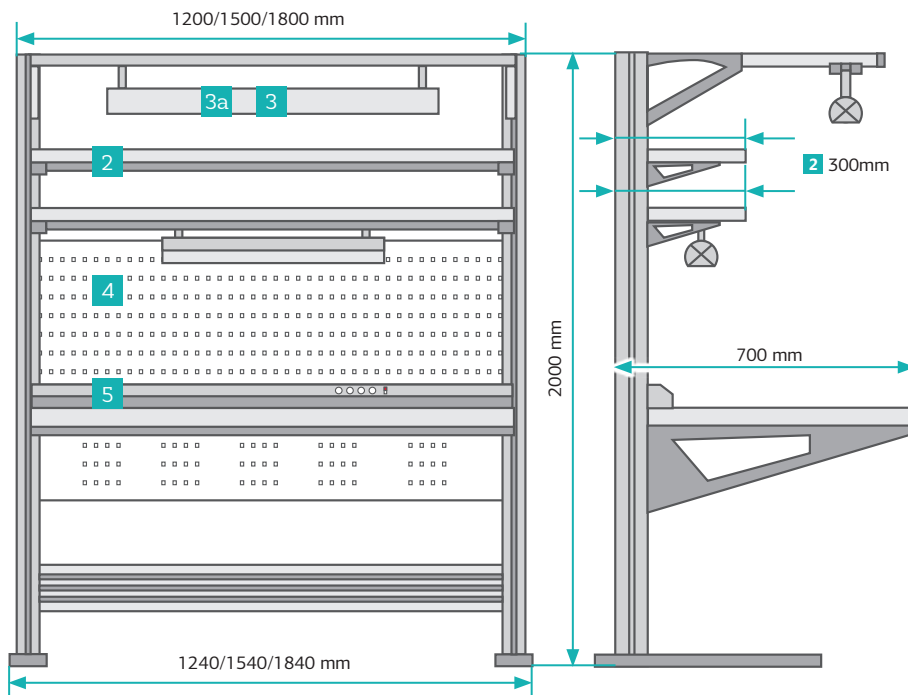





 For this catalog legend,  
please see p. 81







**Alliance automatic** workbenches are distinguished by elegant design, advanced ergonomics and motorized worktop adjustment system, performed by electric drive and simple control unit. ALLIANCE Automatic allows setting tabletop height easily and quickly by simply pressing a button, which is indispensable in certain working processes. Tabletop thickness 25 mm.

Alliance automatic workbenches are supplied in a set with adjustment mechanism, lower slat, main shelf, perforated panel, lighting, power panel.

 700-950 mm
 

  
 200 kg



**2** AL-A-PO/1 Additional shelf   

 1050-1820 mm  100 kg

**3** DL-AA/A Workbench lighting  



An aluminum case with two energy-efficient luminescent 54 W lamps, light direction regulation and shadowless reflector provided. Quick switching on without shimmering, no strobing freeze. Provides at least 1200-lux illuminance at 1000 mm distance

 from floor 1150 – 1980 mm

**3a** DL-AA/S2 LED lighting  



An aluminum case with LED lamp and light direction regulation.

- Color temperature 4700-5300 K
- Luminous flux: 5985 Lm
- Power consumption: 43 W
- Also available with dimmer. [See more on p. 46](#)

**3b** DL/N Under-shelf local lighting  



Additional lighting can be mounted under the main shelf or attached to perforated panel. Suitable for any workbench equipped with upper modules. Angle adjustment 80°

- 2 versions: 60 cm length and 90 cm length
- Luminous flux: 3150/4725 Lm
- Color temperature 4700–5300 K

**4** PFP-AA Perforated panel  

Panel can be equipped with different holders for additional equipment and tools storage — [See more on p.47](#)

 1190/1490/1790×325 mm

**5** EPA-AA  

An aluminum case with four sockets, protective contact, switch and 3 m cable. Can be equipped with additional sockets, fuses, phone jacks and earth leakage circuit breakers.

- nominal load capacity: 10 A







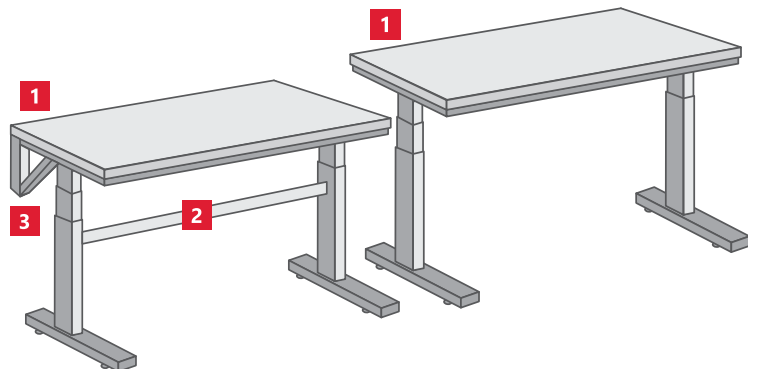
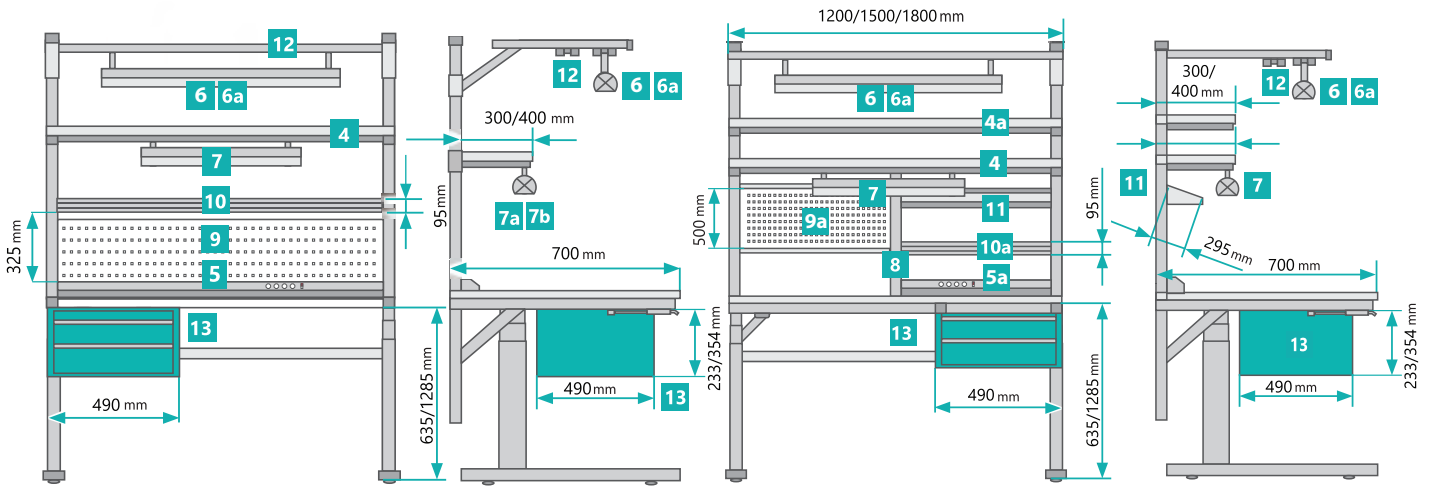





















































All ALLIANCE AUTOMATIC series workbenches and shelves are bicolored by default. When ordering, please mention whether ESD or technical version required

! Optional drawer units, PPS computer case support and keyboard support can't be installed to Alliance Automatic series workbenches.

# SIGMA ELECTRIC WORKBENCH





- 1** SIGMA Electric Workbench     
Sigma Electric workbenches are electrically height adjustable workspaces, supporting any ergonomic requirements of each user  
 635-1285 mm  200 kg  300°  
Max. speed 38mm/s unloaded.  
Stroke length – 650 mm.  
Duty cycle: 10% ~ 2 minutes of continuous use at full load, followed by 18 minutes of pause.  
Ambient temperature: 10 to +40C°.
- 2** Reinforcing crossbar    
Reinforcing crossbar for additional rigidity of workbench.
- 3** Rear rack holders    
Additional holders for rear racks allowing assembly of upper extensions.
- 4** PO Main shelf     
Rear racks included.  
 1000-1800 mm  50 kg
- 4a** PO/1 Additional shelf     
Requires PO Main shelf to be installed. Rear racks excluded.  
 1100-1800 mm  50 kg  depth 300 / 400 mm
- 5** EP Power panel  
- 5a** ½ EP Power panel    
An aluminum case/ half-size case with four sockets and on/off switch as standard. Can be equipped with additional sockets, circuit breaker, automatic fuse, USB charger and RJ 45 data sockets.
- 6** DL/ S2 Classic LED lighting  
- 6a** DL/ S2 Comfort LED lighting    
An aluminum case with LED lamp and light direction regulation. Color temperature 4700-5300 K  
Provides at least 1200-lux illuminance at 1000 mm distance from the light source.  
 from tabletop level 500-1350 mm.  
Also available with dimmer. [See more on p. 46](#)
- 7** DL/N2 Under-shelf local lighting    
Additional lighting can be mounted under the main shelf or attached to perforated panel. Suitable for any workbench equipped with upper modules. Angle adjustment 80.  
2 versions: 60 cm length and 90 cm length.  
Color temperature 4700-5300 K.  
Provides at least 1000-lux illuminance at 1000 mm distance from the light source.
- 8** Middle upright for all items    
Required to hold any ½ item. Three sizes to match standard workbench width.
- 9** PFP Perforated panel  
- 9a** ½ PFP Perforated panel    
Panel can be equipped with different holders for additional equipment and tools storage.  
 10 kg  PFP — 1190/1490/1790×325 mm  
 ½ PFP — 610/760/910×500 mm
- 10** RK Bin rail  
- 10a** ½ RK Bin rail    
Aluminum Bin rail.  
 10 kg  RK — 1110/1410/1710 ×100 mm  
 ½ RK — 530/680/830 ×100 mm
- 11** PN Half-size sloped shelf   
- 11a** PNP Full-size sloped shelf     
Full-size/Half-sized shelf with 10-55° angle adjustment provides comfort monitoring of working equipment.  
 50 kg  534/684/834×295 mm
- 12** IP Cantilever    
Upper slat for fastening drawings, additional lighting and instruments. IP Cantilever can be additionally equipped by retracting KL-1200 mechanism.
- 13** Optional drawer units with reduced depth     
Storage solution for tools and components with depth of 490 mm. Two or three drawers versions available.
- 14** Desk Panel DPG1M  
The Desk Panel DPG1M is a compact desk panel in the DPG series. It features Bluetooth® connection, two favorite positions and a reminder via an LED to remind the users to use their desk. The DPG1M is activated by tilting the desk panel in the same direction as the desk is intended to drive.
- 15** Desk Control™ App  
The Desk Control™ App is developed for users of sit-stand desks. The app allows the users to connect to their desks via Bluetooth® wireless technology and will now remind the user to use their sit-stand desks.
- 16** The Desk Sensor™ 1 (DS1)  
The Desk Sensor™ 1 is a new Anti-Collision™ solution which can limit material damage to a desk or an object if a collision occurs during driving of the desk.

# GAMMA SERIES WORKBENCHES

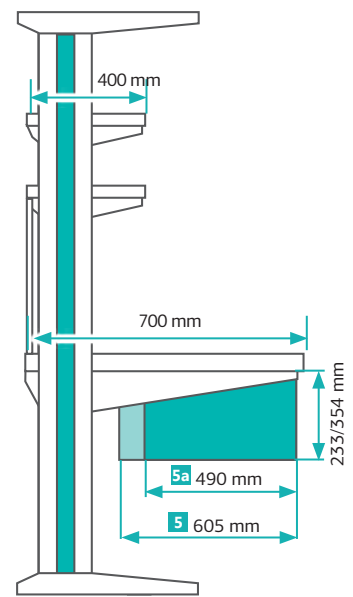
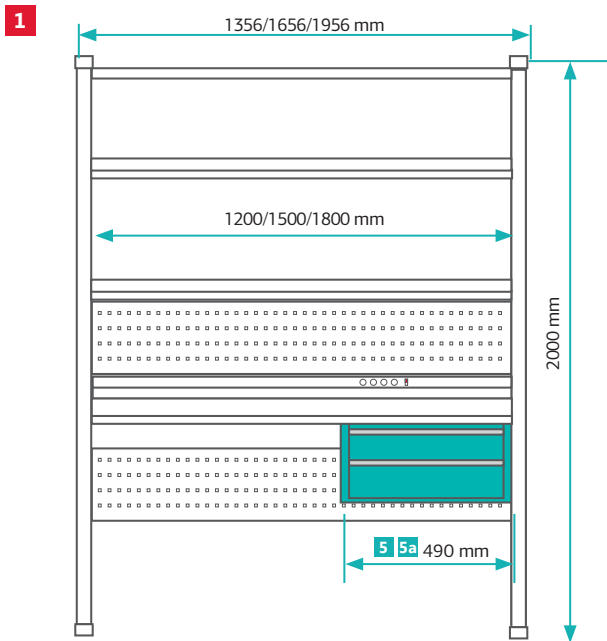

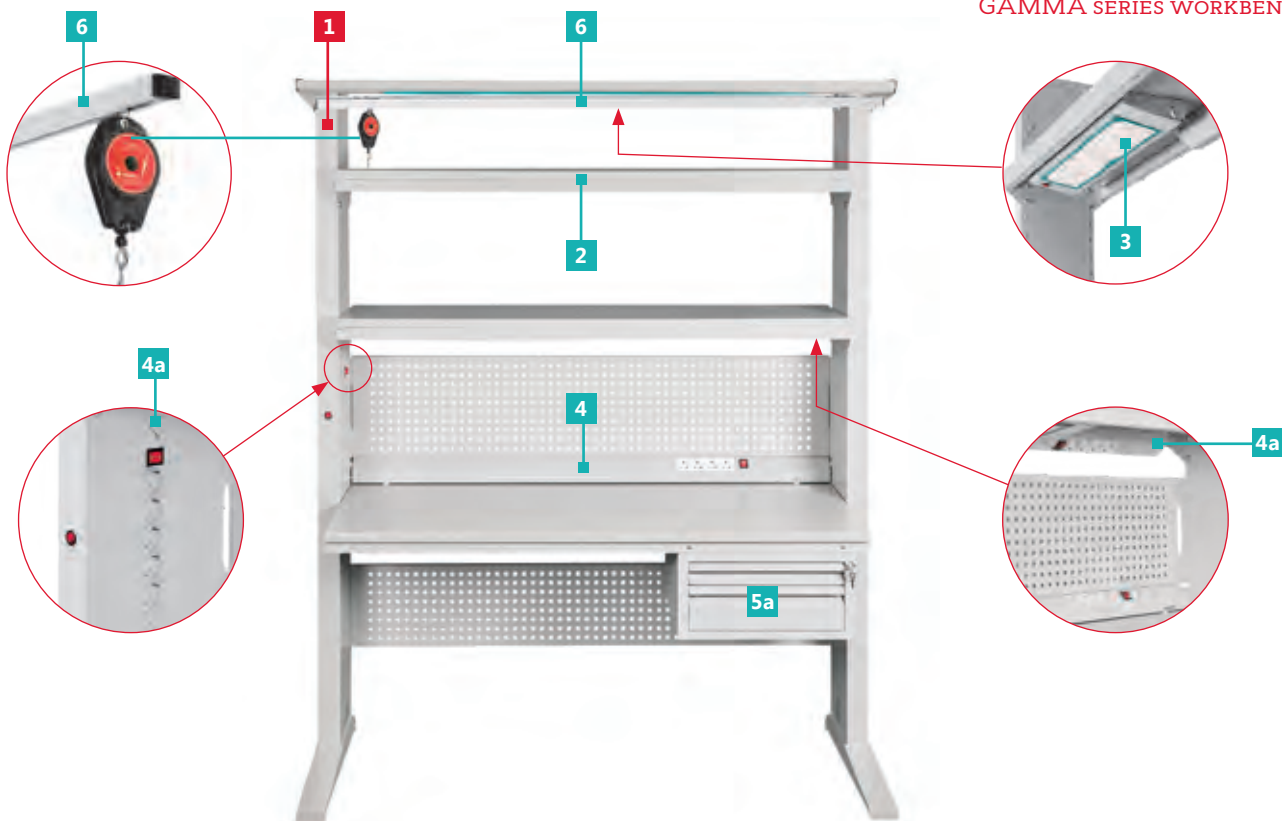

 For this catalog legend, please see p. 81



**GAMMA SERIES** workbenches are based on the concept of clear surfaces, where all technical communications are hidden and the fasteners are organically fit the design.

All horizontal surfaces of the workbench are mounted to L shape supports, which mask built-in technical communications, electrical and lighting connections and all necessary fixture, keeping the workspace clear.

**1** GAMMA Workbench   

The workbench is supplied in a set: workbench with L shape side supports, main shelf, upper LED lighting, upper and lower perforated panels and side built-in power panel.

Available in two versions, depending on the location of built-in power panel: with the right (PR in coding, for example GM-18/PR) or the left (L in coding, for example GM-12/L) power unit in the side panel. The built-in power panel is equipped with 6 sockets (5 with grounding and one without grounding) and a switch button.

Upper LED lighting is built into the top horizontal hanger above the tabletop.

- Color temperature 3950-4000 K
- Luminous flux: 4490 Lm
- Power consumption: 38 W

Provides at least 1260-lux illuminance at 1000 mm distance from the light source.

All technical communications are easily accessible by opening the board in side supports. Tabletop thickness 25 mm.





for tabletop up to 200 kg



for all shelves in total for shelf up to 200 kg



3 options: 740mm, 800mm, 860mm

**2** GM-PO/1 Additional shelf   



1330-1870 mm with a 60 mm pitch







400 mm

**3** GM-DL-6 GAMMA Under-shelf LED Lighting  

Angle adjustment - 10°. - Color temperature 3950-4000 K  
- Luminous flux: 3400 Lm

 748×50×177 mm

**4** GM-EPA Power panel  

**4a** ½ GM-EPA Half-size Power panel  





Half-size Power panel can be mounted below the main shelf or under the tabletop,

GM-EPA Power panel main panel can be mounted on the tabletop with the front side to and fro.

An aluminum case/ two cases with four sockets, protective contact, switch and 3 m cable. Can be equipped with additional sockets, fuses, phone jacks and earth leakage circuit breakers.

- Nominal load capacity: 10 A.

**5** Optional drawer units/    

**5a** Optional drawer units with reduced depth    

Storage solution for tools and components, no place on floor required. Those with reduced to 490 mm depth allow installing various additional equipment under a tabletop. Drawer unit can be placed either on left or right side

**6** GM-IP Cantilever   

It was designed for easy-to-reach attaching of drawings, lighting and instruments. GM-IP Cantilever can be additionally equipped by retracting KL-1200 mechanism.

**7** GM-RK bin rail  

Aluminum rail for bin storage placed along workbench length.

 1147/1447/1747×100 mm

GAMMA workbenches are bicolored by default; the main color is light gray RAL 7035, additional – turquoise RAL 5021. Technical version workbenches are supplied with gray (RAL 7035) edges, in antistatic version - with turquoise (RAL 5021) edges.

# CLASSIC series workbenches



When ordering, please mention whether ESD or technical version, and whether dark grey RAL 7012 or light grey RAL 7035 color required.

For this catalog legend, please see p. 81

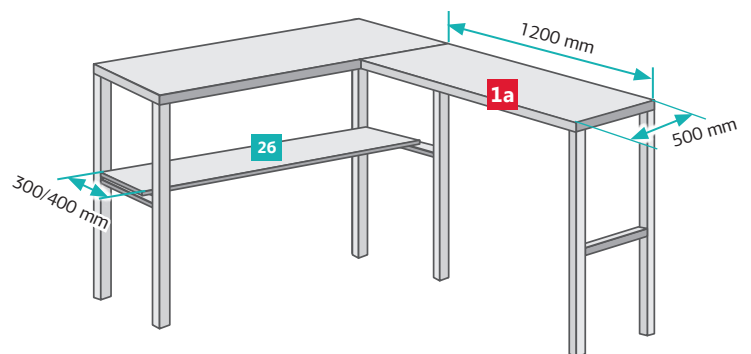
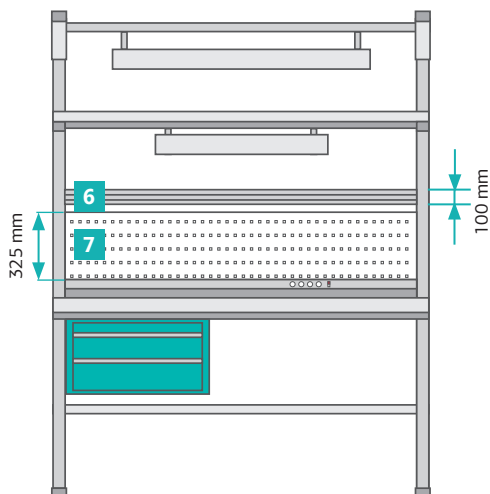
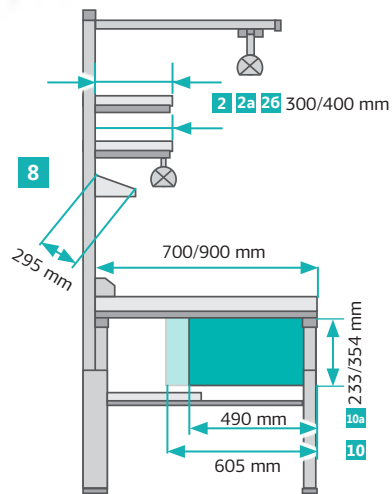
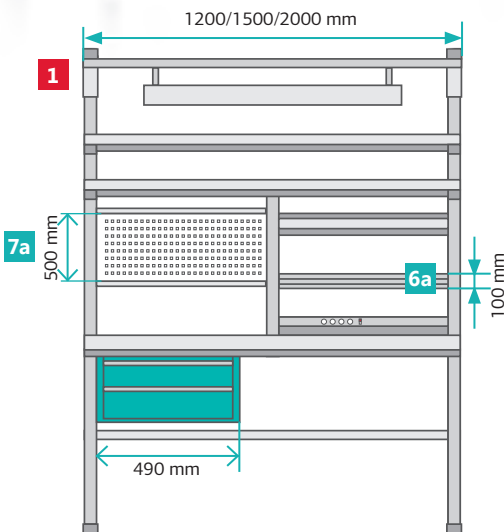

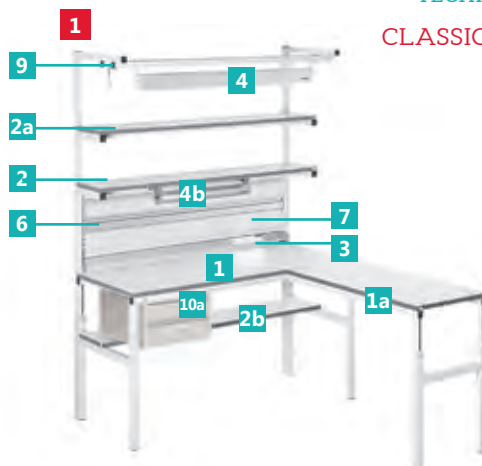
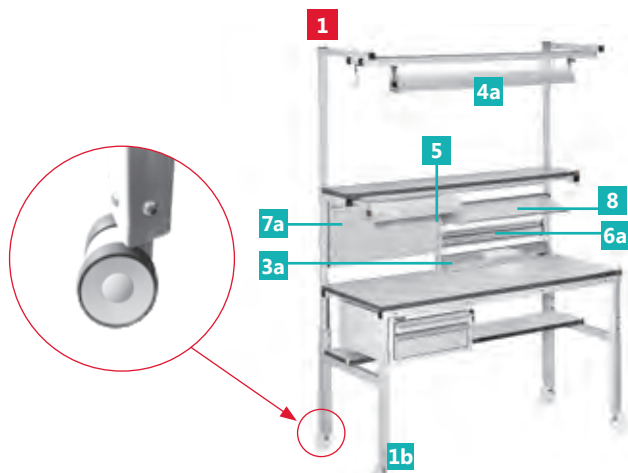

**1** Classic Workbench

These workbenches can be placed in a line to make a common working area with no gaps. Universal design allows fitting out the workplace with additional equipment and drawer units. Tabletop thickness 25 mm.

650–900 mm 300 kg 300°C

**1a** US-1 Corner workbench

Additional side outlier for Classic workbenches.

**1b** K-SR and D-75 Classic workbench wheels set

Can be mounted to any Classic workbench, allows making it movable. K-SR holder and D-75 wheels shall be ordered separately.

**2** PO Main shelf

Rear racks included.

1000–1800 mm 50 kg 300/400 mm

**2a** PO/1 Additional shelf

Requires PO Main shelf to be installed. Rear racks excluded.

1000–1800 mm 50 kg  
300/400 mm

**2b** PO/2 Underneath shelf

Not compatible with TP-01/P and TP-10/P Optional drawer units.

50 kg 300/400 mm

**3** EP Power panel

**3a** ½ EP Power panel

An aluminum case/ half-size case with four sockets, protective contact, switch and 3 m cable. Can be equipped with additional sockets, fuses, phone jacks and earth leakage circuit breakers.

- Nominal load capacity: 10 A

**4** DL/A Workbench lighting

An aluminum case with two energy-efficient luminescent 54 W lamps, light direction regulation and shadowless reflector provided. Quick switching on without shimmering, no strobing freeze.

Provides at least 1200-lux illuminance at 1000 mm distance from the light source.

500–1350 mm from tabletop

**4a** DL/S2 Workbench LED lighting

An aluminum case with LED lamp and light direction regulation. Color temperature 4700–5300 K

Provides at least 1200-lux illuminance at 1000 mm distance from the light source.

500–1350 mm from tabletop.

Also available with dimmer. See more on p. 46

**4b** DL/N2 Under-shelf local lighting

Additional lighting can be mounted under the main shelf or attached to perforated panel.

Suitable for any workbench equipped with upper modules. Angle adjustment ±60°

- 2 versions: 60 cm length and 90 cm length
- Color temperature 4700–5300 K

Provides at least 1000-lux illuminance at 1000 mm distance from the light source. Also available with dimmer.

See more on p. 46

**5** Middle upright for all items

Required to hold any ½ item. Three sizes to match standard workbench width.

**6** RK Bin rail

**6a** ½ RK Bin rail

Aluminum rail for bin storage placed along workbench length.

RK — 1110/1410/1710×100 mm 10 kg

½RK — 530/680/830×100 mm

**7** PFP Perforated panel

**7a** ½ PFP Perforated panel

Panel can be equipped with different holders for additional equipment and tools storage — See more on p.47

PFP- 1190/1490/1790×325 mm 10 kg

½PFP - 610/760/910×500 mm

**8** PN Half-sized Sloped shelf

**8a** PNP Full-sized Sloped shelf

Sloped shelf with 10–55° angle adjustment provides comfort monitoring of working equipment.

PN 534/684/834×295 mm 50 kg

PNP 1111/1411/1711×295 mm

**9** IP Cantilever

Upper slat for fastening drawings, additional lighting and instruments. IP Cantilever can be additionally equipped with retracting KL-1200 mechanism — See more on p.44

**10** Optional drawer units/

**10a** Optional drawer units with reduced depth

Storage solution for tools and components, no place on floor required. Those with reduced to 490 mm depth allow installing various additional equipment under a tabletop.

Drawer unit can be placed either on left or right side.

# COMFORT SERIES WORKBENCHES





When ordering, please mention whether ESD or technical version, and whether dark grey RAL 7012 or light grey RAL 7035 color required.

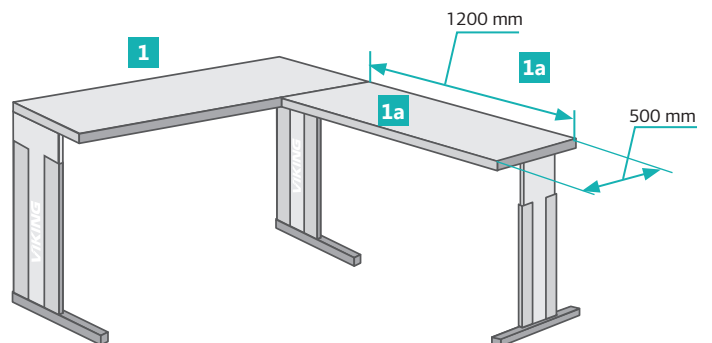
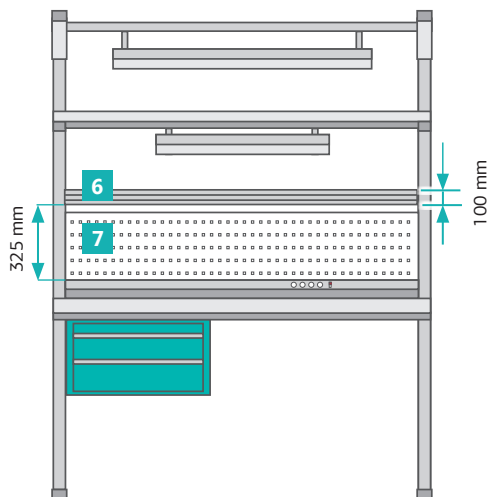
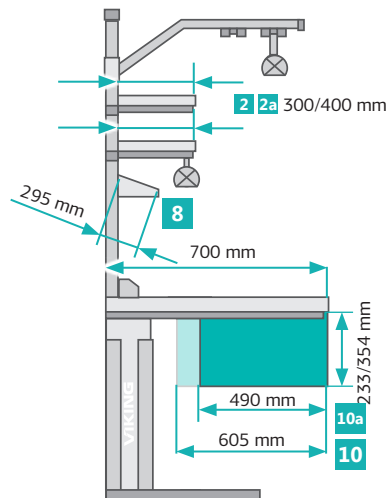
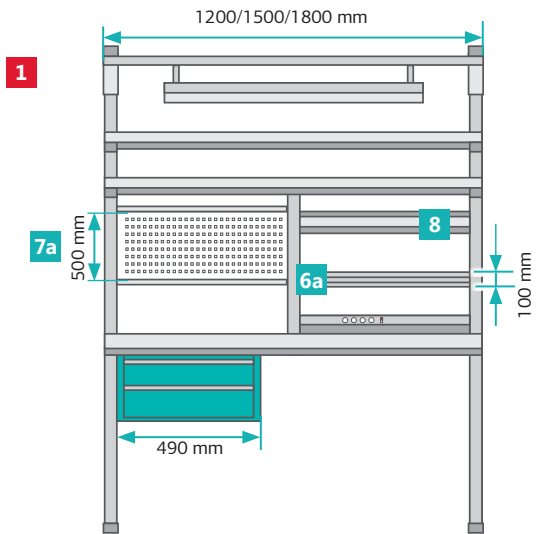

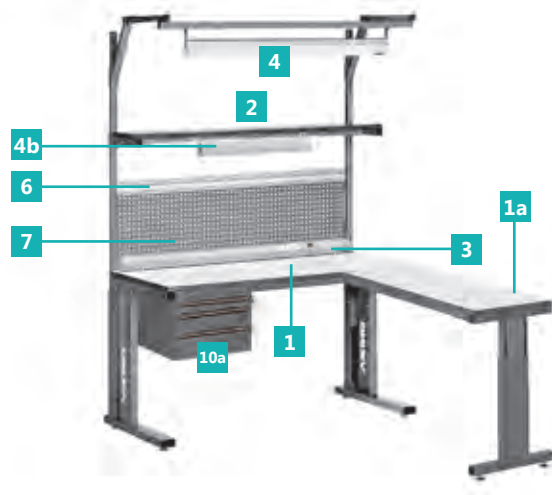
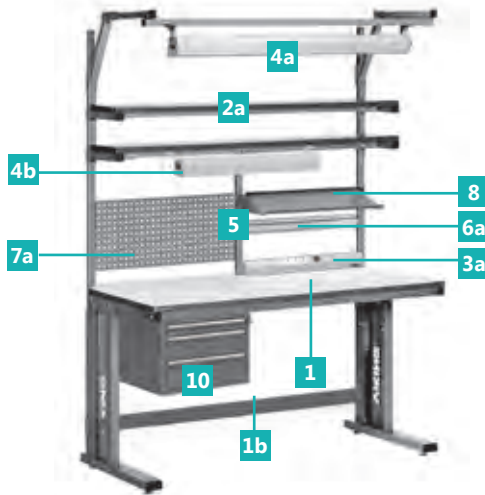
For this catalog legend, please see p. 81













- 1** COMFORT Workbench   

Workbenches are settled on L-shape side supports and can be additionally equipped with a number of applicative modules. Tabletop thickness 25 mm.



 800–950 mm  200 kg





 300°C
- 1a** US-1 Comfort Corner workbench   

Additional side outlier for Comfort workbenches.
- 1b** UP Additional lower slat 



Provides extended stability and rigidity of the workbench
- 2** PO Main shelf   





Rear racks included.

 1000–1800 mm  50 kg



 300/400 mm
- 2a** PO/1 Additional shelf   

Requires PO Main shelf to be installed. Rear racks excluded.



 1000–1800 mm  50 kg



 300/400 mm
- 3** EP Power panel  
- 3a** ½ EP Power panel  

An aluminum case/ half-size case with four sockets, protective contact, switch and 3 m cable. Can be equipped with additional sockets, fuses, phone jacks and earth leakage circuit breakers.



  - Nominal load capacity: 10 A
- 4** DL/A Comfort Workbench lighting  



An aluminum case with two energy-efficient luminescent 54 W lamps, light direction regulation and shadowless reflector provided. Quick switching on without shimmering, no strobing freeze. Provides at least 1200-lux illuminance at 1000 mm distance from the light source.

 500-1350 mm from tabletop  See more on p. 46

Also available with dimmer.
- 4a** DL/S2 Workbench LED lighting  

An aluminum case with LED lamp and light direction regulation. Color temperature 4700-5300 K Provides at least 1200-lux illuminance at 1000 mm distance from the light source.



 500-1350 mm from tabletop  See more on p. 46





- 4b** DL/N2 Under-shelf local lighting  

Additional lighting can be mounted under the main shelf or attached to perforated panel. Suitable for any workbench equipped with upper modules. Angle adjustment ±60°



  - 2 versions: 60 cm length and 90 cm length
  - Color temperature 4700–5300 K





Provides at least 1000-lux illuminance at 1000 mm distance from the light source.

Also available with dimmer.  See more on p. 46
- 5** Middle upright for all items  

Required to hold any ½ item. Three sizes to match standard workbench width.
- 6** RK Bin rail  
- 6a** ½ RK Bin rail  

Aluminum rail for bin storage placed along workbench length.







 RK — 1110/1410/1710×100 mm  10 kg

 ½ RK — 530/680/830×100 mm
- 7** PFP Perforated panel  
- 7a** ½ PFP Perforated panel  



Panel can be equipped with different holders for additional equipment and tools storage.  See more on p.47



 10 kg







 PFP — 1190/1490/1790×325 mm

 ½ PFP — 610/760/910×500 mm
- 8** PN Half-sized Sloped shelf   
- 8a** PNP Full-sized Sloped shelf   

Sloped shelf with 10-55° angle adjustment provides comfort monitoring of working equipment.

 PN 534/684/834×295 mm  50 kg

 PNP 1111/1411/1711×295 mm
- 9** IP Cantilever  

Upper slat for fastening drawings, additional lighting and instruments. IP Cantilever can be additionally equipped by retracting KL-1200 mechanism.  See more on p.44
- 10** Optional drawer units/   
- 10a** Optional drawer units with reduced depth   

Storage solution for tools and components, no place on floor required. Those with reduced to 490 mm depth allow installing various additional equipment under a tabletop. Drawer unit can be placed either on left or right side.

# CONSTANT SERIES WORKBENCHES





When ordering, please mention whether ESD or technical version required.

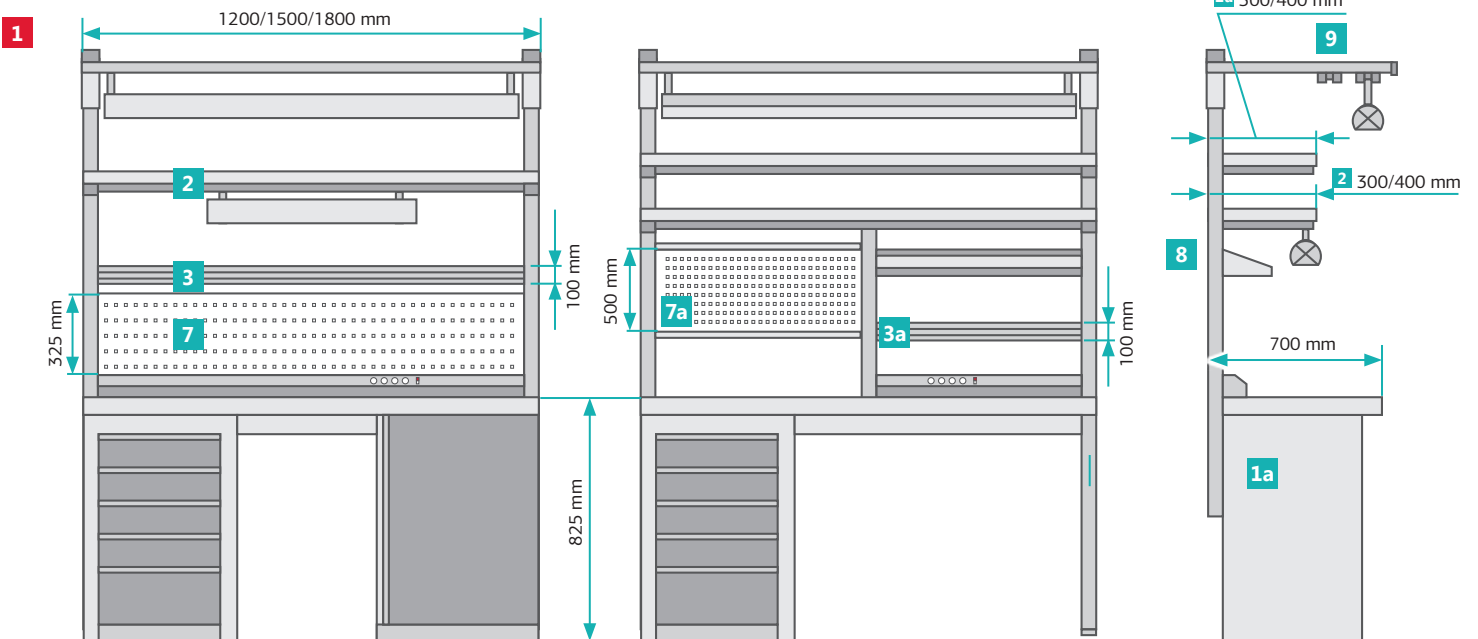

For this catalog legend, please see p.81

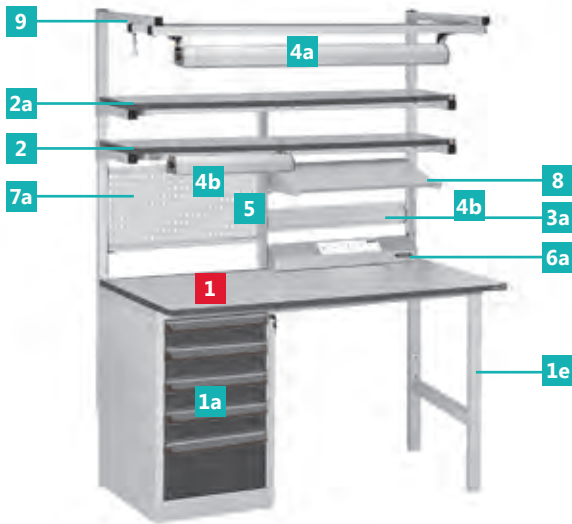





**1 SR CONSTANT workbenches**   

These workbenches cannot be height-adjusted.  
Tabletop thickness 25 mm.  
 300 kg  300°C







**As a support, CONSTANT workbenches can have:**



- 1a** Cabinet unit with five drawers on telescopic runners and a lock (+DR-05 in code);
- 1b** Cabinet unit with three bigger drawers on telescopic runners and a lock (+DR-03 in code);
- 1c** Cabinet with two shelves and a lock (+ TMB-01 in code);
- 1d** Cabinet with one drawer and two shelves in a locked section (+ TMB-02 in code);
- 1e** Legs.





**CONSTANT worktop supports can be used in any combination for 1500 mm and 1800 mm width workbenches. 1200 mm width workbenches should have legs as one support.**  
Workbench with 3-drawer cabinet and 2-shelves cabinet has +DR-03+TMB-01 in code, for example 1500 mm width workbench ordering code SR-15-7+DR-03+TMB-01.



**Cabinets and drawer units used as worktop supports are bicolored by default.**



**2 PO Main shelf**     
Rear racks included.  
 1000-1800 mm  50 kg  300/400 mm

**2a PO/1 Additional shelf**     
Requires PO Main shelf to be installed. Rear racks excluded.  
 1100-1800 mm  50 kg  300/400 mm



**3 RK Bin rail**  

**3a 1/2 RK Bin rail**    
Aluminum rail for bin storage placed along workbench length.  
 RK — 1110/1410/1710×100 mm  10 kg  
 1/2 RK — 530/680/830×100 mm



**4 DL/A Workbench lighting**    
An aluminum case with two energy-efficient luminescent 54 W lamps, light direction regulation and shadowless reflector provided. Quick switching on without shimmering, no strobing freeze.  
Provides at least 1200-lux illuminance at 1000 mm distance from the light source.  
 500-1350 mm from tabletop

**4a DL/S2 Workbench LED lighting**  



An aluminum case with LED lamp and light direction regulation.  
- Color temperature 4700-5300 K  500-1350 mm from tabletop  
Provides at least 1200-lux illuminance at 1000 mm distance from the light source.



**4b DL/N2 Under-shelf local lighting**  

Additional lighting can be mounted under the main shelf or attached to perforated panel. Suitable for any workbench equipped with upper modules. Angle adjustment ±60°  
- 2 versions: 60 cm length and 90 cm length  
- Color temperature 4700-5300 K. Provides at least 1000-lux illuminance at 1000 mm distance from the light source.  
Also available with dimmer.  See more on p. 46



**5 Middle upright for all items**  



Required to hold any 1/2 item. Three sizes to match standard workbench width.





**6 EP Power panel**  

**6a 1/2 EP Power panel**  

An aluminum case/ half-size case with four sockets, protective contact, switch and 3 m cable. Can be equipped with additional sockets, fuses, phone jacks and earth leakage circuit breakers.  
- Nominal load capacity: 10 A



**7 PFP Perforated panel**  



**7a 1/2 PFP Perforated panel**  

Panel can be equipped with different holders for additional equipment and tools storage.  
 PFP — 1190/1490/1790×325 mm  10 kg  
 1/2 PFP — 610/760/910×500 mm  See more on p.47

**8 PN Half-sized Sloped shelf**   

**8a PNP Full-sized Sloped shelf**   

Sloped shelf with 10-55° angle adjustment provides comfort monitoring of working equipment.  
 PN 534/684/834×295 mm  50 kg  
 PNP 1111/1411/1711×295 mm

**9 IP Cantilever**  

Upper slat for fastening drawings, additional instruments. IP Cantilever can be additionally equipped by retracting KL-1200 mechanism.

# OSTROV SERIES WORKBENCHES



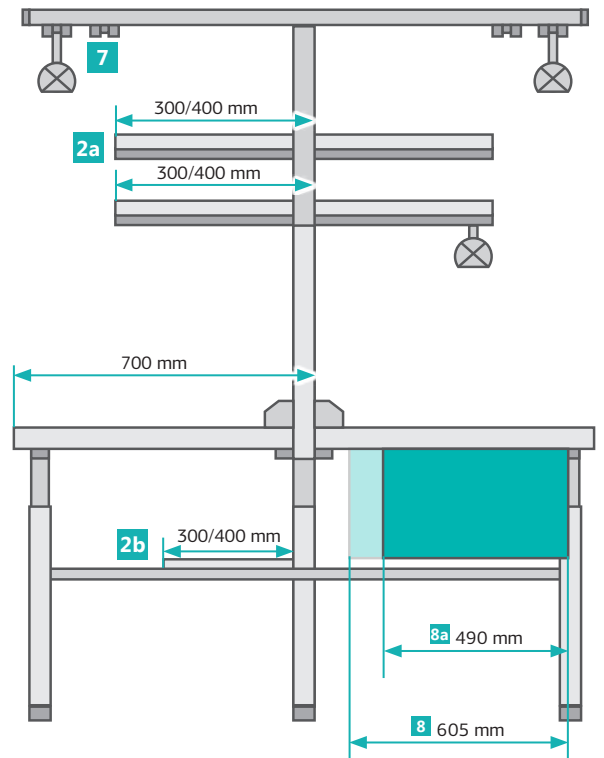
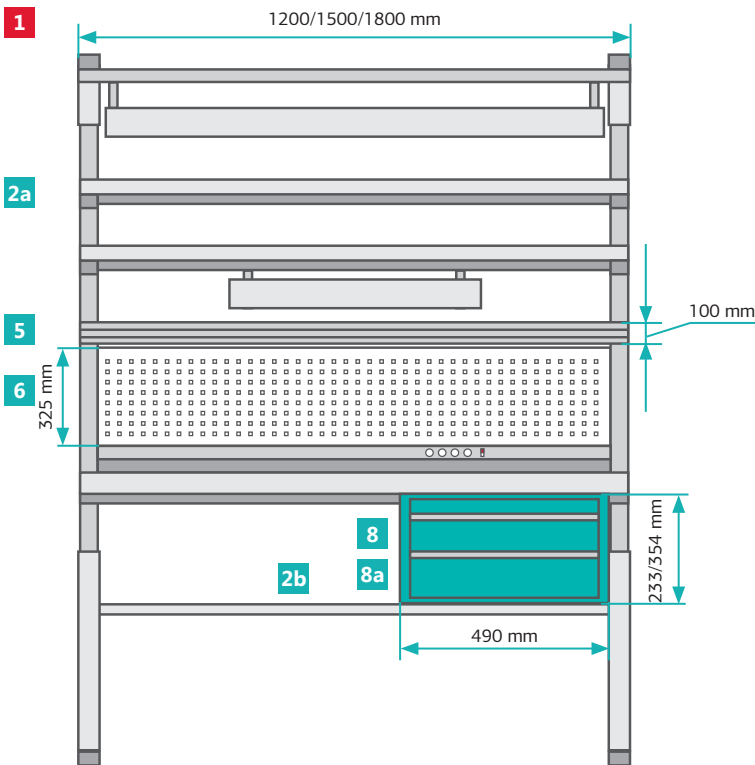

When ordering, please mention whether ESD or technical version, and whether dark grey RAL 7012 or light grey RAL 7035 color required.

For this catalog legend, please see p. 81

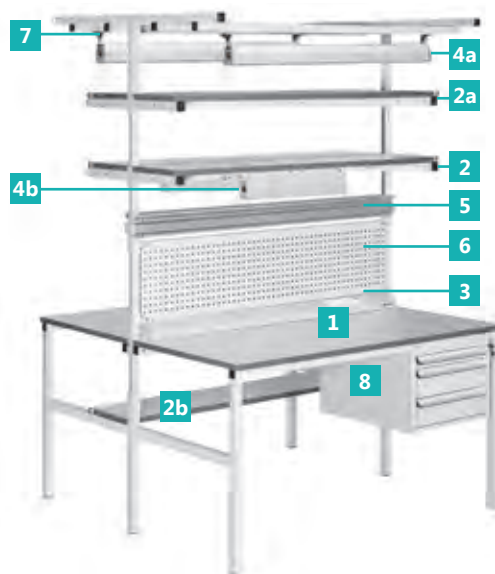





**1** OSTROV Workbench   

Double-sided workbench allows effective use of space. Basic configuration includes Rear racks and 300 mm shelves for each side of the workstation. Tabletop thickness 25 mm.



 720–905 mm



 300°C  each side 300 kg

**2a** PO-O Additional shelf   



Should be mounted to Rear racks of the workbench



 1100–1800 mm

 300/400 mm  50 kg

**2b** PO/2 Underneath shelf   



Not compatible with TP-01/P and TP-10/P Optional drawer units.

 300/400 mm  50 kg

**3** EP-O Double Power panel  

Two aluminum cases each with four sockets, protective contact, switch and 3 m cable. Can be equipped with additional sockets, fuses, phone jacks and earth leakage circuit breakers.

- Nominal load capacity: 10 A



**4** DL-O/A Double Workbench lighting  

T-shape rack with two aluminum cases each with two energy-efficient luminescent 54 W lamps, light direction regulation and shadowless reflector provided. Quick switching on without shimmering, no strobing freeze. Provides at least 1200-lux illuminance at 1000 mm distance from the light source.

 500-1350 from tabletop

**4a** DL-O/S2 Double Workbench LED lighting  

T-shape rack with two aluminum cases each with LED lamp and light direction regulation. Color temperature 4700-5300 K. Provides at least 1200-lux illuminance at 1000 mm distance from the light source.



 500-1350 from tabletop.  See more on p. 46

**4b** DL/N2 Under-shelf local lighting  

Additional lighting can be mounted under the main shelf or attached to perforated panel. Suitable for any workbench equipped with upper modules. Angle adjustment 80°



- 2 versions: 60 cm length and 90 cm length
- Color temperature 4700–5300 K. Provides at least 1000-lux illuminance at 1000 mm distance from the light source.

Also available with dimmer.  See more on p. 46

**5** RK-O Double bin rail  



Double aluminum rail for storage bins is placed along workbench length.

 10 kg

 2×(1112/1412/1712)×100 mm  See more on p.47.



**6** PFP-O Double perforated panel  

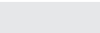

The panel can be equipped by different holders for additional equipment and tools storage.

 2×(1112/1412/1712)×325 mm  See more on p.38.

**7** IP Cantilever 

Upper slat for fastening drawings, additional lighting and instruments. IP Cantilever can be additionally equipped by retracting KL-1200 mechanism.

**8** Optional drawer units/   

**8a** Optional drawer units with reduced depth   

Storage solution for tools and components, no place on floor required. Those with reduced to 490 mm depth allow installing various additional equipment under a tabletop.

Drawer unit can be placed either on left or right side.

# VERSTAK SERIES TECHNICAL WORKBENCHES

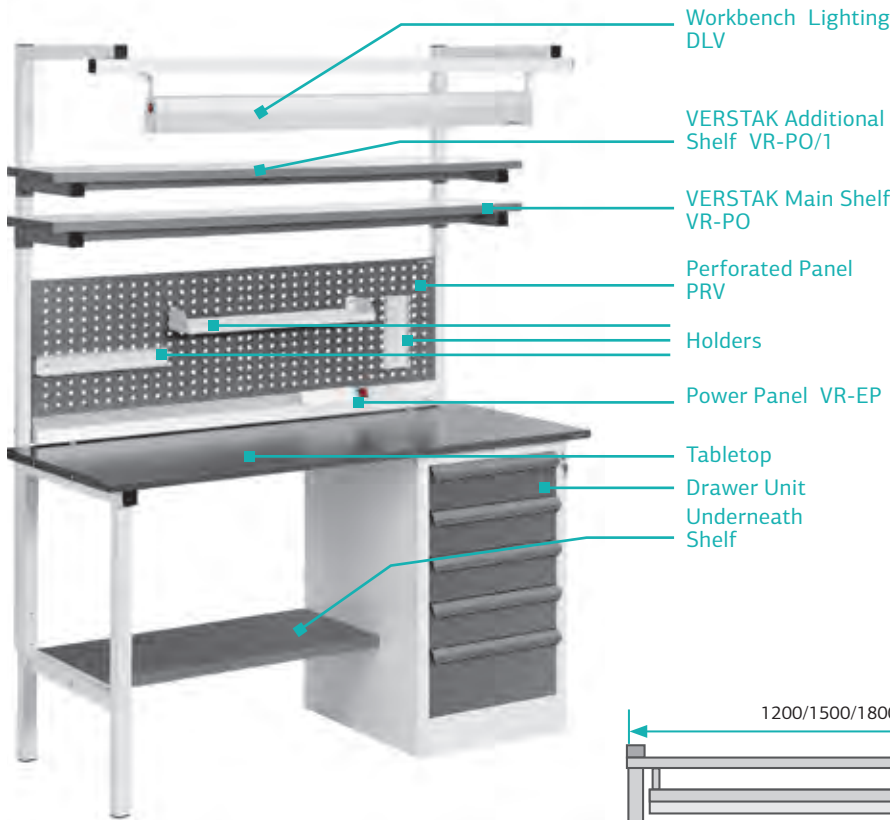

- Workbench Lighting DLV
- VERSTAK Additional Shelf VR-PO/1
- VERSTAK Main Shelf VR-PO
- Perforated Panel PRV
- Holder
- Power Panel VR-EP
- Tabletop
- Drawer Unit
- Underneath Shelf

VERSTAK series offer module workbenches of heightened rigidity and durability with distributed load capacity of over 500 kg. These workbenches are only available in technical /non-antistatic version.



For this catalog legend, please see p. 81

Perforated panel PRV, Power panel VR-EPA and Workbench lighting DLV are mounted to Rear Racks that are supplied in a set with Main shelf or should be ordered separately if Main Shelf is not required. Perforated panel is supplied in a set with Small Rear Racks thus can be ordered separately from other upper modules..

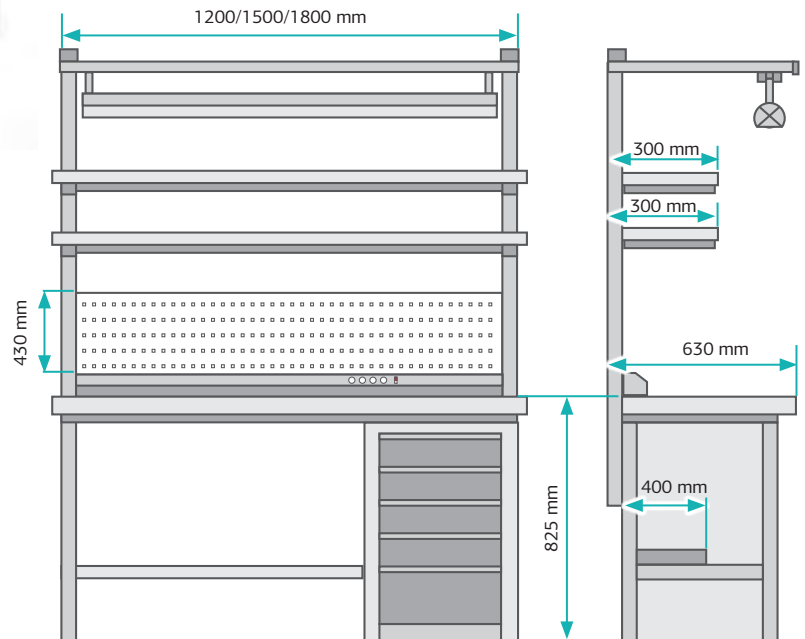

Maximum functionality is achieved by possibility of using a range of tabletops, supports and additional equipment.

There are 5 types of tabletops

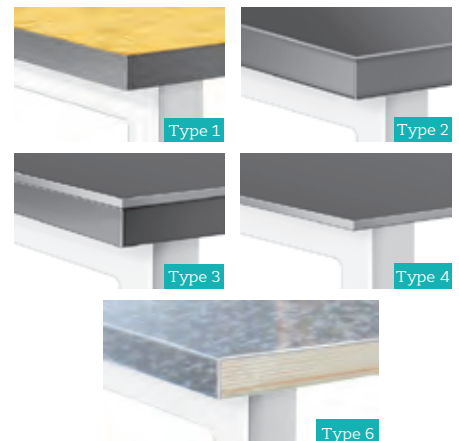

- |   |   |
|---|---|
| 1 | 21 mm thick plywood with light grey plastic edges.  |
| 2 | 21 mm thick plywood covered by 2 mm dark grey metal sheet, the latter is bent over edges. |
| 3 | 21 mm thick plywood with light grey plastic edges covered by 6 mm dark grey metal sheet.  |
| 4 | 6 mm thick dark grey metal sheet.   |
| 6 | 21 mm thick plywood with 1.2 mm zinc metal sheet, the latter is bent over edges.          |

There are five standard types of worktop supports:

- 1a** Cabinet unit with five drawers on telescopic runners and a lock (+DR-05);
- 1b** Cabinet unit with three bigger drawers on telescopic runners and a lock (+DR-03);
- 1c** Cabinet with two shelves and a lock (+TMB-01);
- 1d** Cabinet with one drawer and two shelves in a locked section (+TMB-02);
- 1e** Legs.

These supports can be used in any combination, except for 1200 mm width VERSTAK workbenches that should have legs as one of the tabletop supports.



	VERSTAK with a drawer unit (DR-03 or DR-05)	VR-12+DR-03/No.	VR-12+DR-05/No.	1200×630 mm
		VR-15+DR-03/No.	VR-15+DR-05/No.	1500×630 mm
		VR-18+DR-03/No.	VR-18+DR-05/No.	1800×630 mm
	VERSTAK with a cabinet (TMB-01 or TMB-02)	VR-12+TMB-01/No.	VR-12+TMB-02/No.	1200×630 mm
		VR-15+TMB-01/No.	VR-15+TMB-02/No.	1500×630 mm
		VR-18+TMB-01/No.	VR-18+TMB-02/No.	1800×630 mm
	VERSTAK with different combinations of cabinets (TMB-01, TMB-02) and drawer units (DR-03, DR-05)	VR-15+DR-05+DR-05/No.	VR-15+DR-03+DR-03/No.	1500×630 mm
		VR-15+DR-03+DR-05/No.	VR-15+TMB-01+TMB-01/No.	
		VR-15+TMB-01+TMB-02/No.	VR-15+TMB-02+TMB-02/No.	
		VR-15+DR-05+TMB-01/No.	VR-15+DR-05+TMB-02/No.	1800×630 mm
		VR-15+DR-03+TMB-02/No.	VR-15+DR-03+TMB-01/No.	
		VR-18+DR-05+DR-05/No.	VR-18+DR-03+DR-03/No.	
VR-18+DR-03+DR-05/No.	VR-18+TMB-01+TMB-01/No.	1800×630 mm		
VR-18+TMB-01+TMB-02/No.	VR-18+TMB-02+TMB-02/No.			
VR-18+DR-05+TMB-01/No.	VR-18+DR-05+TMB-02/No.			
VR-18+DR-03+TMB-02/No.	VR-18+DR-03+TMB-01/No.			

**Note:** No. in the workbench code corresponds to tabletop type (1, 2, 3, 4 or 5). For example, VR-12+TMB-01/3.

PRV Perforated Panel for VERSTAK workbench (small shelf and 2 holders included).	PRV-12	for 1200 mm width workbenches
	PRV-15	for 1500 mm width workbenches
	PRV-18	for 1800 mm width workbenches
DLV Workbench Lighting. Requires Main shelf or Rear Racks to be installed.	DLV-12	for 1200 mm width workbenches
	DLV-15	for 1500 mm width workbenches
	DLV-18	for 1800 mm width workbenches
DLS2 VERSTAK LED Upper Workbench Lighting.	DLS-12	for 1200 mm width workbenches
	DLS-15	for 1500 mm width workbenches
	DLS-18	for 1800 mm width workbenches
VR-PO VERSTAK Main Shelf.	VR-PO-12	1200×300 mm
	VR-PO-15	1500×300 mm
	VR-PO-18	1800×300 mm
VR-PO/1 VERSTAK Additional Shelf. Requires Main shelf.	VR-PO/1-12	1200×300 mm
	VR-PO/1-15	1500×300 mm
	VR-PO/1-18	1800×300 mm
VR-EP VERSTAK Power Panel. Requires Main shelf or Rear Racks or PRV.	VR-EP-12	for 1200 mm width workbenches
	VR-EP-15	for 1500 mm width workbenches
	VR-EP-18	for 1800 mm width workbenches
DL/N2 Under-shelf local lighting. Requires Main shelf or PRV2 Also available with dimmer. See more on p. 46.	DL/N-6	600 mm
	DL/N-9	900 mm
Rear Racks.	KZS	1500 mm
Small Rear Racks.	UKZS	900 mm

# VERSTAK GRAND HEAVY-DUTY WORKBENCHES

Verstak Grand heavy-duty workbenches designed to work in a standing position and feature reinforced structure that can withstand a distributed load of up to 2000 kg.

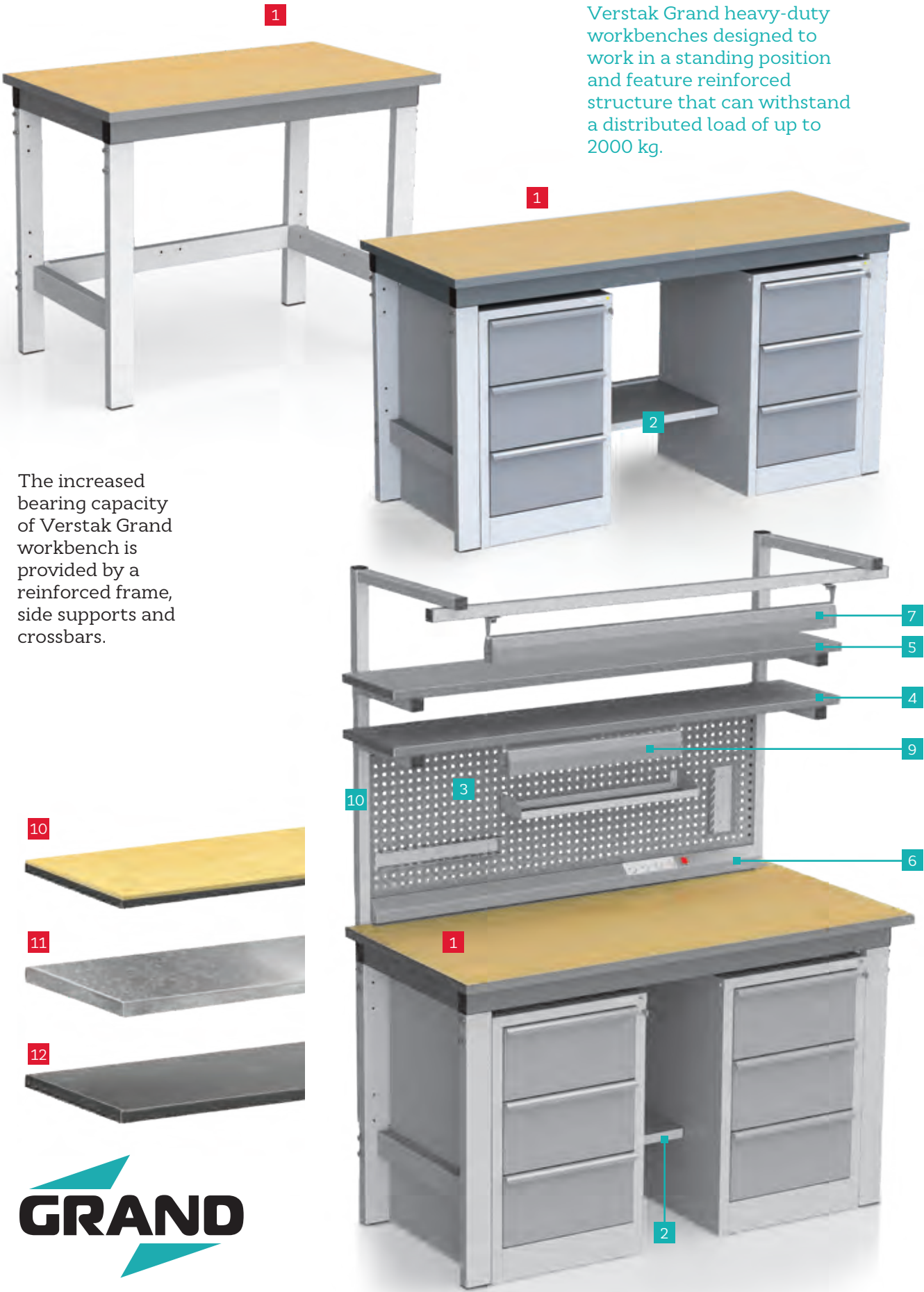

The increased bearing capacity of Verstak Grand workbench is provided by a reinforced frame, side supports and crossbars.

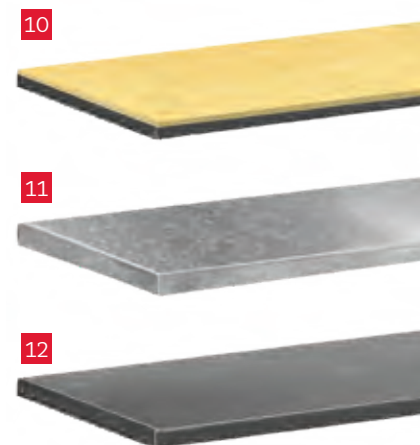

Verstak Grand series workbenches tabletop height is **930 mm**, working surface can't be height adjusted.  
The reinforced VIKING Grand workbenches are available in four standard sizes: **1200, 1500, 1800 and 2000 mm**.

Verstak Grand workbenches can be equipped with 3 types of tabletops:

- 10 type 10** - 30mm plywood with RAL7012 edge
- 11 type 11** - 30mm plywood covered with 2mm thick metal sheet bent on 4 sides, metal sheet painted in RAL7012
- 12 type 12** - 30mm plywood covered with 1.2mm thick galvanized sheet metal bent from 4 sides.

The workbench can be additionally equipped with a perforated panel (PRV) with shortened rear uprights (UZS), which makes it possible to install additionally only a power panel (VR-EPA).

Perforated panel (PRV) can be also combined with other upper modules: upper lighting of the working surface (DLV), upper shelf (VR-PO), which is supplied in a set with rear uprights, under shelf lighting (DL / N), electrical power panel (VR-EPA).

The perforated panel is supplied complete with two universal tool holders and one hinged shelf.

In the case of only upper Workbench lighting (DLV) ordering, one shall also order a set of rear uprights (KZS).

The lower shelf can be installed between 2 additional cabinets or between 1 cabinet and lower slat.

№№		EQUIPMENT			
<b>1</b>		<b>VERSTAK GRAND HEAVY-DUTY WORKBENCHES</b>			
<b>Workbench width</b>		<b>1200 mm</b>	<b>1500 mm</b>	<b>1800 mm</b>	<b>2000 mm</b>
<b>Tabletop type</b> ( # )	<b>10</b>	<b>VR/G-12/10</b>	<b>VR/G-15/10</b>	<b>VR/G-18/10</b>	<b>VR/G-20/10</b>
	<b>11</b>	<b>VR/G-12/11</b>	<b>VR/G-15/11</b>	<b>VR/G-18/11</b>	<b>VR/G-20/11</b>
	<b>12</b>	<b>VR/G-12/12</b>	<b>VR/G-15/12</b>	<b>VR/G-18/12</b>	<b>VR/G-20/12</b>
<b>Tabletop dimensions, mm</b>		1200×700	1500×700 mm	1800×700	2000×700
<b>2</b>	<b>Lower shelf for VERSTAK GRAND workbench</b>	<b>PO-VR/G-12/1</b> Lower shelf for a workbench with 1 cabinet 460×400mm	<b>PO-VR/G-15/1</b> Lower shelf for a workbench with 1 cabinet 760×400mm	<b>PO-VR/G-18/1</b> Lower shelf for a workbench with 1 cabinet 1060*400mm	
		<b>PO-VR/G-12/3</b> Lower shelf for a workbench without cabinets 960×400mm	<b>PO-VR/G-15/2</b> Lower shelf for a workbench with 2 cabinets 260×400mm	<b>PO-VR/G-18/2</b> Lower shelf for a workbench with 2 cabinets 560*400mm	
			<b>PO-VR/G-15/3</b> Lower shelf for a workbench without cabinets 1260×400mm	<b>PO-VR/G-18/3</b> Lower shelf for a workbench without cabinets 1560*400mm	
<b>3</b>	<b>PRV Perforated Panel for VERSTAK GRAND workbench</b> (small shelf and 2 holders included)	<b>PRV-12</b> 1200×430 mm	<b>PRV-15</b> 1500×430 mm	<b>PRV-18</b> 1800×430 mm	
<b>4</b>	<b>VERSTAK Main Shelf</b> (rear racks included)	<b>VR-PO-12</b> 1200×300 mm	<b>VR-PO -15</b> 1500×300 mm	<b>VR-PO-18</b> 1800×300 mm	
<b>5</b>	<b>VR-PO/1 VERSTAK GRAND Additional Shelf</b> (requires Main shelf)	<b>VR-PO-12/1-3</b> 1200×300 mm	<b>VR-PO-15/1-3</b> 1500×300 mm	<b>VR-PO-18/1-3</b> 1800×300 mm	
<b>6</b>	<b>VR-EP VERSTAK GRAND Power Panel</b> (requires Main shelf or Rear Racks or PRV)	<b>VR-EP-12</b>	<b>VR-EP-15</b>	<b>VR-EP-18</b>	
<b>7</b>	<b>DLV Workbench Lighting</b> (requires Main shelf or Rear Racks to be installed.) Also available with dimmer. See more on p. 46.	<b>DLV-12</b>	<b>DLV-15</b>	<b>DLV-18</b>	
<b>7</b>	<b>DL-S2 Workbench LED Lighting</b> (requires Main shelf or Rear Racks to be installed.)	<b>DLV-12/S2</b>	<b>DLV-15/S2</b>	<b>DLV-18/S2</b>	
<b>9</b>	<b>DL/N2 Under-shelf local lighting</b> (requires Main shelf or PRV)		<b>DL/N2-6</b> 600 mm <b>DL/N2-9</b> 900 mm		
<b>10</b>	<b>KZS Rear Racks</b>		1500 mm		
	<b>UKZS Small Rear Racks</b>		900 mm		

# TITAN SERIES HEAVY DUTY TECHNICAL WORKBENCHES



Titan series technical furniture is designed for mechanical works, which require reinforced load capacities, especially in machine-building and metalworking industries, in workshops and car services.

Main features of Titan series furniture:

- 2000 kg load capacity for workbenches, reinforced runners for drawers and durable wheels for movable workstations and trolleys;
- Two types of shock resistant and high-abrasion tabletops; various sets of modules allow selecting an optimal workplace;
- Demountable construction, which consists of four parts, provides convenience of transportation.

Two types of tabletops available for the workbench:



Default colors combination is RAL 5021 (turquoise), RAL 9005 (black) and RAL 9010 (white). Matte paint texture

30 mm thick plywood coated with 10 mm shockproof plastic

30 mm thick plywood coated with 6 mm sheet metal

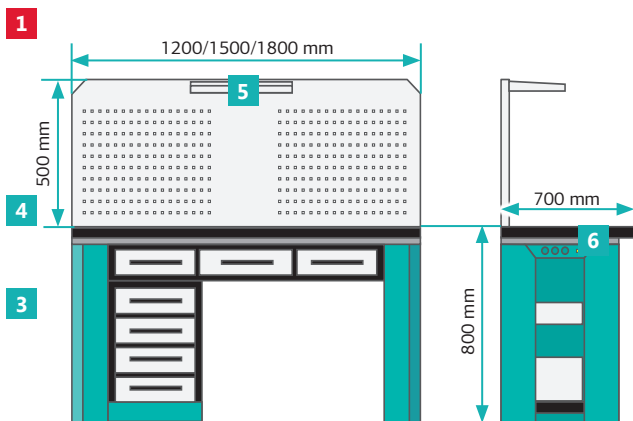

1 VT/B



## 1 1 VT/R, VT/B TITAN Heavy-duty Workbench

TITAN heavy-duty workbench is a high tech construct that doesn't need any utility supports under the tabletop. All the stiffeners organically fit the design of the workbench.

Load capacity and rigidity are achieved through optimally calculated 1.5 mm thick structural iron profiles.

TITAN heavy-duty workbenches in basic version (VT/B) are supplied with technological plugs in a frame under the tabletop, heavy duty workbenches in expanded version (VT/R) are supplied with reinforced telescopic drawers:

- 2 small drawers 300×80×478 mm for 1200 wide mm workbenches
- 3 small drawers 300×80×478 mm for 1500 wide mm workbenches
- 2 small drawers 300×80×478 mm and 1 big drawer 600×80×478 mm for 1800 wide mm workbenches

All heavy-duty workbenches are equipped with small side shelves under the tabletop.



2000 kg distributed



300 kg dynamic



80 kg per drawer



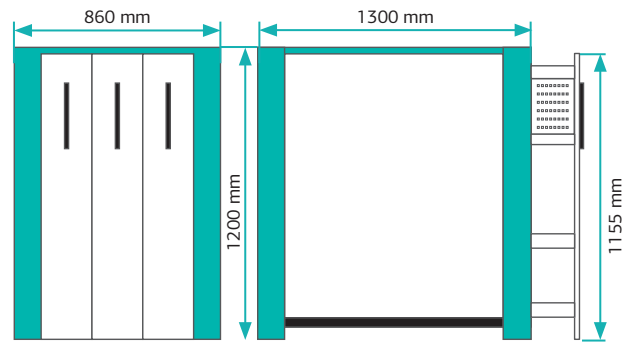



**2** Attachable drawer unit with door TMB-01/VT

Drawer unit for tools and accessories storage is placed under the heavy duty workbench frame and is mounted by bolting if necessary. Drawer unit is equipped with a door and an inner shelf.

 405×610×600 mm  20 kg  80 kg per shelf

**3** Attachable drawer unit with drawers DR-04/VT

Attachment drawer unit for tools and accessories storage is placed under the heavy workbench and is mounted by bolting if necessary. It is equipped with 4 drawers 300\*80\*450 mm with reinforced load characteristics.

 405×610×600 mm  30 kg  
 80 kg per drawer

**4** Perforated panel PFP/VT

It is designed for fastening additional equipment and tools; it can be equipped with K/VT series tools holders.

 30 kg

**5** Hinged LED lamp DL/VT

Metal case with LED lamp is fastened in the central zone of the perforated panel.

- Illumination of the working surface at a distance of 1000 mm from the light source – at least 1000 lux for central zone.
- 10 ° angle adjustment provided.

 745×255×50 mm

**6** Power panel EPA/VT

Trapezoidal power panel is installed under the tabletop of heavy-duty workbenches inside the lateral support. Power panel is equipped with three protected European socket outlets, power switch and three-meter cable network, which is output through the support of heavy workbench.

- Nominal load: 10 A
- Cross-section of grounding cable: 1.5 mm

**7** Tools cabinet SHK/VT

Titan series reinforced tools cabinet can be used for milling, drilling and CNC lathes tools storage, as well as punches and matrix plate-bending tools.

Inner perforation of telescopic drawers allows mounting shelves for different tools storage and adjusts shelves' height with a 25 mm pitch.

 860×1200×1300 mm

Default colors combination is RAL 5021 (turquoise), RAL 9005 (black) and RAL 9010 (white). Matte paint texture

 700 kg per unit  80 kg per shelf

Demountable construction provides an easy transportation; an assembled cabinet can be moved with a stacking truck or a loader.

The inner perforation of cabinet's shelves can be provided according to customers' requirements.

**7a** PO-SHK/VT Tool cabinet's inner shelf with a mat

Tools cabinet's inner shelf can be installed inside the drawer console and is equipped with anti-slip mat.

 136×30×1170mm

**7b** PO-35-SHK/VT Tool cabinet's internal shelf with 35mm holing

Tools cabinet's inner shelf can be installed inside the drawer console. It has perforation of 35 mm in diameter with protective plastic inserts.

 136×30×1170mm

**7c** PO-60-SHK/VT Tool cabinet's internal shelf with 60mm holing.

Tools cabinet's inner shelf can be installed inside the drawer console. It has perforation of 60 mm in diameter with protective plastic inserts.



 136×30×1170mm

**7d** PFP-SHK/VT Perforated restraining wall

Restraining perforated wall for tools cabinet can be installed between two inner shelves, allows delimiting the space of two adjacent consoles of the cabinet.

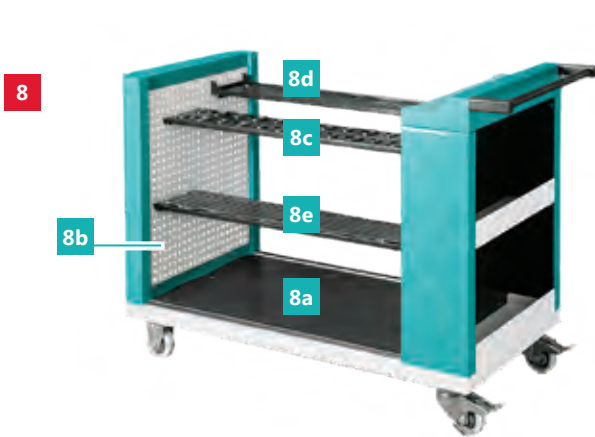
 1190×572 mm



**8** TT/BT Transportation cart  

Titan series reinforced transportation cart is designed for heavy tools and accessories storage and movement between manufacturing sectors. The cart is equipped with rotary wheels, 2 of them with brakes, it is also equipped with the convenient handle.

Default colors combination is RAL 5021 (turquoise), RAL 9005 (black) and RAL 9010 (white). Matte paint texture.

Demountable construction facilitates transportation and gives the opportunity to remove main shelves and use internal space for transportation of gauge loads.

Individual different dimensions, perforation and shelves available on request.

**8d** TT-B / VT Internal shelf with anti-slip rubber and upturns

Internal shelf should be installed between two inner perforated panels of transportation cart base vertical wall and Restraining Section. The shelf is equipped with anti-slip rubber and upturns.

 100 kg  190×990×33 mm

**8e** TT-K / VT Internal shelf with anti-slip rubber

Internal shelf should be installed between two inner perforated panels of transportation cart base vertical wall and Restraining Section. The shelf is equipped with anti-slip rubber.



 100 kg  190×990×20 mm

Transportation cart consists of several modules:

**8a** TT-01/VT Transportation cart base

The bottom of the transportation cart base structure is covered with 3mm anti-slip rubber; the vertical wall is equipped with two additional lateral shelves with up to 30 kg load capacity each and a convenient handle.

Sectional construction of the trolley makes it possible to use the entire internal space for dimensional goods transportation.

 700×1005×1422 mm  up to 700 kg

**8b** TT-OS / VT Restraining Section



Should be installed on the opposite side of the trolley's vertical wall with holder, allows limiting the inner zone of the trolley and installing internal shelves between two inner perforated panels.



 700×810×113 mm

**8c** TT-P / VT Internal shelf with perforation

Internal shelf should be installed between two inner perforated panels of transportation cart base vertical wall and Restraining Section.

The shelf is equipped with tool storage system designed for reliable fixation of milling, drilling and CNC lathes tools which is represented by two types of perforation (30 mm and 56 mm in diameter) with protective plastic inserts.

 100 kg  190×990×20 mm

**9** Shelving STS/VT  

Reinforced shelving with four height adjustable shelves. No additional floor leveling required. Available in RAL 9005 (black) и RAL 9010 (white) colors. Matte paint texture.

 per unit 800 kg  per shelf 350 kg



9

TITAN SERIES HEAVY DUTY TECHNICAL WORKBENCHES





**10** Movable workstation VTM 

Titan series movable workstation is a compact movable workbench with four drawers and four reinforced polyurethane wheels, two of which are equipped with a stopper; it prevents a workbench rolling during a working process. Movable workstations are equipped with five small and one bigger separate sections for accessories on a working surface; it is also equipped with side shelves below the tabletop and a convenient handle.

Can be additionally equipped with the perforated cover screen and the hinged lamp.

 workstation 600×900×500 mm  130 kg

 two drawers 400×160×435 mm  
 two drawers 400×80×435 mm

Default colors combination is RAL 5021 (turquoise), RAL 9005 (black) and RAL 9010 (white).

Matte paint texture.

 per working surface 150 kg

 per telescopic drawer 80 kg

**10a** Perforated cover screen for movable workstation PFP/VTM

Perforated cover screen is designed for tools and additional accessories storage above the tabletop working area. The cover screen should be attached to the backside of the mobile workstation by screw connection and allows locking of working zone of the movable station with a key if necessary.

 600×505×100 mm  20 kg

**10b** Hinged LED lamp DL/VT

Metal case with LED lamp is fastened in the central zone of the perforated screen.

 457×40×10.8 mm

**ADDITIONAL ACCESSORIES FOR PERFORATED PANELS OF HEAVY WORKBENCH AND MOVABLE WORKSTATION**

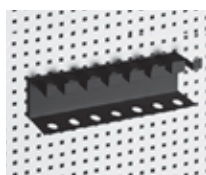

**K-01/VT** Hook for tweezers and equipment with small handles.  
 174×70×40 mm

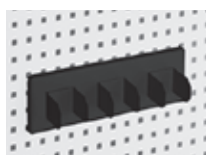

**K-04/VT** Hook for any tools.  
 174×45×35 mm

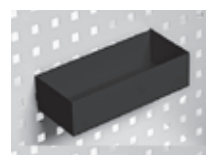

**K-08/VT** Tray for small components and bottles.  
 174×45×82 mm

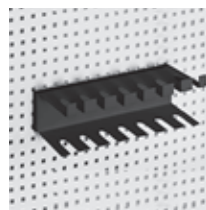

**K-02/VT** Hook for screwdrivers.  
 174×70×40 mm



**K-05/VT** Holder for screwdrivers and 9-13 mm diameter drills.  
 175×100×32 mm

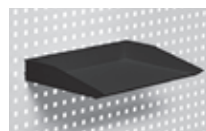

**K-09/VT** Tray for A4-size papers.  
 311×45×225 mm

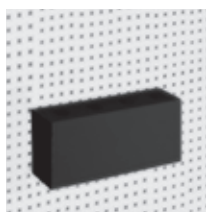

**K-03/VT** Holder for pliers.  
 174×85×47 mm



**K-06/VT** Hooks for spanners.  
 188×181×52 mm



**K-10/VT** A4-size papers holder.  
 233×289×30 mm





**K-07/VT** Double hook for heavy instruments.  
 37×41×92 mm





**K-11** Small aseptic and other bottles holder.  
 56×115×68 mm

## SPECIALIZED WORKBENCHES



- 1 ALF-U Alpha Simplified  

**Simplified** Alpha series workbench without upper modules. Alpha universal workbenches allow several extensions: optional drawer unit, box with protective plastic fibers and power panel

- 2 EPA-ALF-U Box with protective plastic fibers on box lid's edges  

Metal box with power panel is mounted to the back side of ALPHA universal workbench. The box's lid is covered with plastic fibers to protect power panel from dust and cuttings. Can be also used as a worktop extension which makes the workbench depth 180 mm more. Power panel consists of 8 sockets in an aluminum case with protective contact and 3 m cable. Nominal load capacity: 10 A.  
Available in technical and ESD versions.

- 3 Optional drawer units  

- 3a Optional drawer units with reduced depth 

**Storage** solution for tools and components, no place on floor required. Those with reduced to 490 mm depth allow installing various additional equipment under a tabletop.

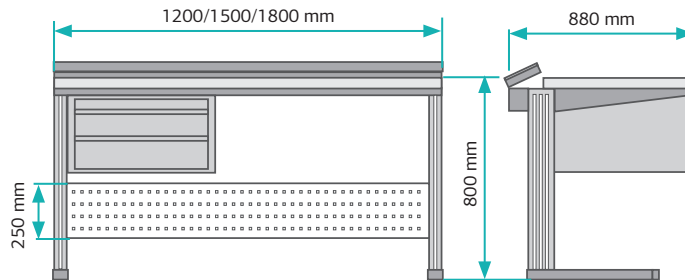

## SPECIALIZED WORKBENCHES FOR OPTICAL FIBER HANDLING



**Two** different types available for purchase: Workbench set and single workbench.

- 1 SET SOV-12/15/18 ESD Specialized workbench set for optical fiber handling 

The set includes workbench itself, 300 mm main shelf and lighting. Workbench's worktop and main shelf are covered with black ESD plastic (RAL 9005) to provide convenience for optical fibers works. Available only in ESD version.

-  650–900 mm  300 kg  300°C

- 2 SOV-12/15/18 Classic ESD Specialize workbench for optical fiber handling 

**Workbench's** worktop is covered with black ESD plastic (RAL 9005) to provide convenience for optical fibers works. Available only in ESD version.

-  650–900 mm  300 kg  300°C

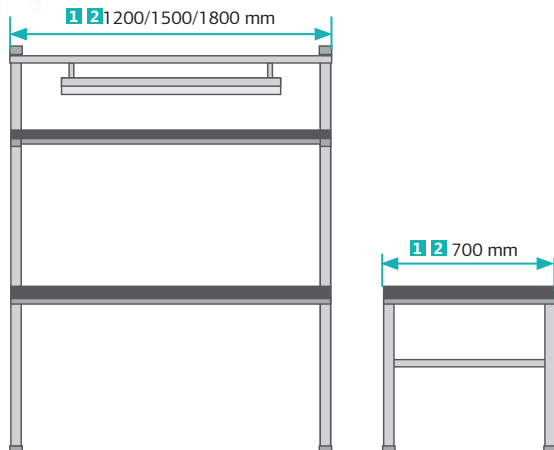

SU Universal workbenches



**UNIVERSAL** workbenches do not allow any upper extension, but can be placed in a line with no gaps. 700 mm and 900 mm depth SU workbenches can be equipped with all types of Optional drawer units.

650-900 mm 300 kg

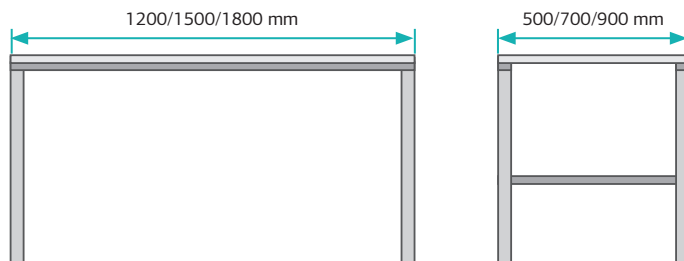

SK-01 Movable computer equipment workbench



**Space-saving** movable workbench for computer and measurement equipment storage and transportation.

Movable workbench is equipped with four 50 mm casters, two of which are with brakes and PPK-02 keyboard support.

785-1040 mm 300 kg

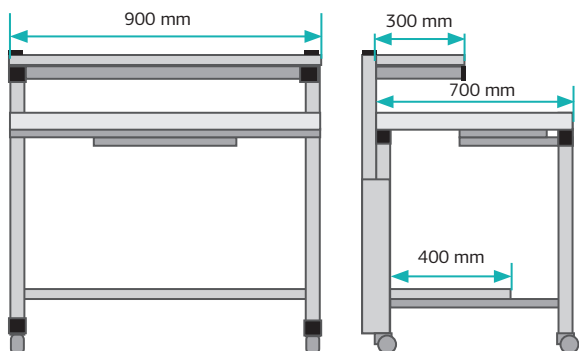

USS-SU-7/9 Corner connecting workbench



Corner connecting workbench is used to build up inseparable working area being a connector for two standard Classic, Comfort or Constant workbenches put at right angle. Increased depth of tabletop and load capacity of 200 kg allows storing and using heavy or bulky equipment.

Corner connecting workbench is produced in 2 sizes to match 700 mm depth workbenches and 900 mm depth workbenches. Perforated panel, main and additional shelves, lighting units and power panels can be mounted to corner connecting workbench on request.

675-890 mm 100 kg

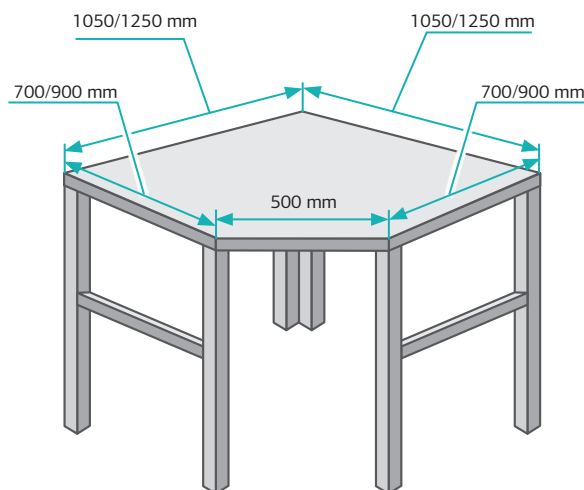

# WIRE HARNESS WORKBENCH



Wire harness workbench with 0° to 80° angle adjustable worktop made of 1.5 mm thick powder-painted steel allows using magnetic plates with holders, retainers, corner posts and wire breakout systems which help to hold wires and form bundles on wire harness workbench. Magnetic plates are equipped with two potent (with 20 kg/s pull off force) magnets each thus allowing the usage of up to 5 kg bundles without their spontaneous movements.

Worktop angle adjustment and fixation is performed by side clamping handles.

Workbench supports unit dimensions: 1425×690 mm.

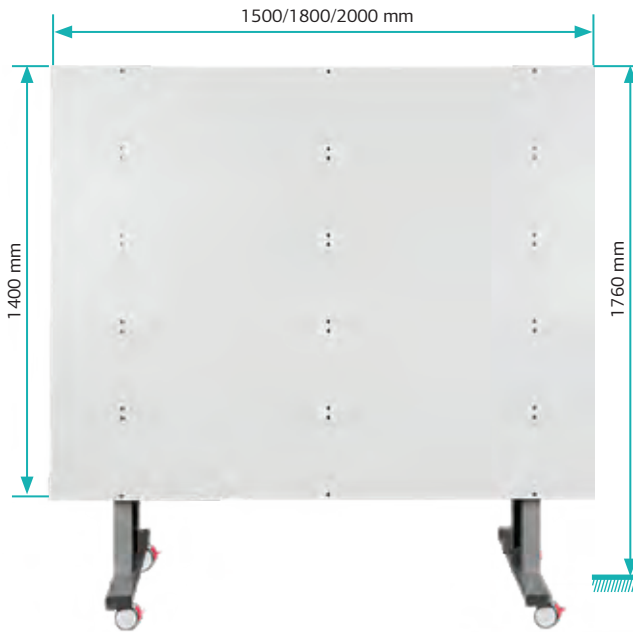

Steel worktop available in three versions (width×height)

- SR-ZHG-15 (1500×1400 mm),
- SR-ZHG-18 (1800×1400 mm),
- SR-ZHG-20 (2000×1400 mm).

### Workbench height

- in horizontal position of the worktop — 800 mm
  - in vertical position of the worktop — 1760 mm
- Available only in technical version. Supplied in a set with casters.



# WIRE HARNESS WORKBENCH ACCESSORIES



TYPE OF THE MAGNETIC PLATE	USED FOR HOLDERS	DIMENSIONS OF THE PLATE, MM
<b>1</b> MP-ZHG-1	RER75-S6-X ER.5-E4-X CPH.75-S8-X CPL.75-S8-X	30×80
<b>2</b> MP-ZHG-2	RER2.0-S6-X ER1.25-E4-X	35×110
<b>3</b> MP-ZHG-3	SHH3-S8-X	20×190
<b>4</b> MP-ZHG-4	Separate angle hook	
<b>5</b> MP-ZHG-5	PBSC12-X	
<b>6</b> MP-ZHG-6	PBSC3-X	

## 5 Spring wire breakout system

**Harness** board spring and spring linkage holds wire ends secure while harness is being fabricated. Wires simply pull out from spring when harness is removed.

CODE	DESCRIPTION	SPAN BETWEEN FASTENINGS LENGTH)
PBSC12-X	Spring wire breakout system, should be mounted to linkage	76.2 mm
PBSC6-X		152.4 mm



**Different** types of holders, retainers, corner posts and wire breakout systems, which help to hold wires and form bundles on wire harness workbench. They should be mounted on one of three types of magnetic plates.

CODE	DIMENSIONS (W×H×D)	MAX. BUNDLE DIAMETER	COMMENTS
<b>1</b> Harness elastic retainer			
RER.75-S6-X	30×56.1× ×28.4 mm	19 mm	Cable bundles are formed as cable bundles are inserted. Completed bundles can be easily removed
Harness replacement elastic band for RER.75-S6-X.			
RER.75E-X			The elastic band is replaceable
<b>2</b> Harness elastic retainer			
RER2.0-S6-X	33.3×100.2× ×71.4 mm	50.8 mm	Cable bundles are formed as cable bundles are inserted. Completed bundles can be easily removed
Harness replacement elastic band for RER2.0-S6-XX			
RER2.0E-X			The elastic band is replaceable
<b>3</b> Low profile elastic retainer			
ER.5-E4-X	49.8×25.4× ×14.2 mm	12.7 mm	Cable bundles are formed as cable bundles are inserted. Completed bundles can be easily removed
ER1.25-E4-X	73.7×50.8× ×24.1 mm	31.8 mm	
<b>4</b> Corner post			
High profile corner post			
CPH.75-S8-X	22.9×47.8× ×40.8 mm	19 mm	Designed to pre-form tight bundles at harness corners and breakouts. Top arm rotates upward for easy removal of completed harness
Low profile corner post			
CPL.75-S8-X	22.4×27.4× ×38.6 mm	19 mm	

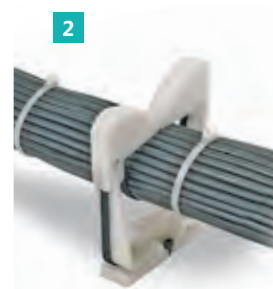
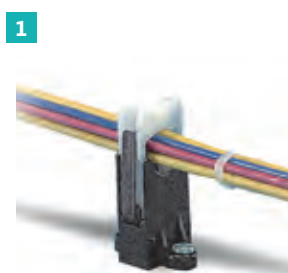

# PACKING WORKSTATION

Viking packing workstation is an adjustable ergonomic workstation that helps to easily access all packaging materials - cartons, tape, paper, bubble wrap or others.

Lately it is important to meet quickly growing demand of packing and logistics needs, which means that the workstation needs to be as ergonomic and efficient as possible.

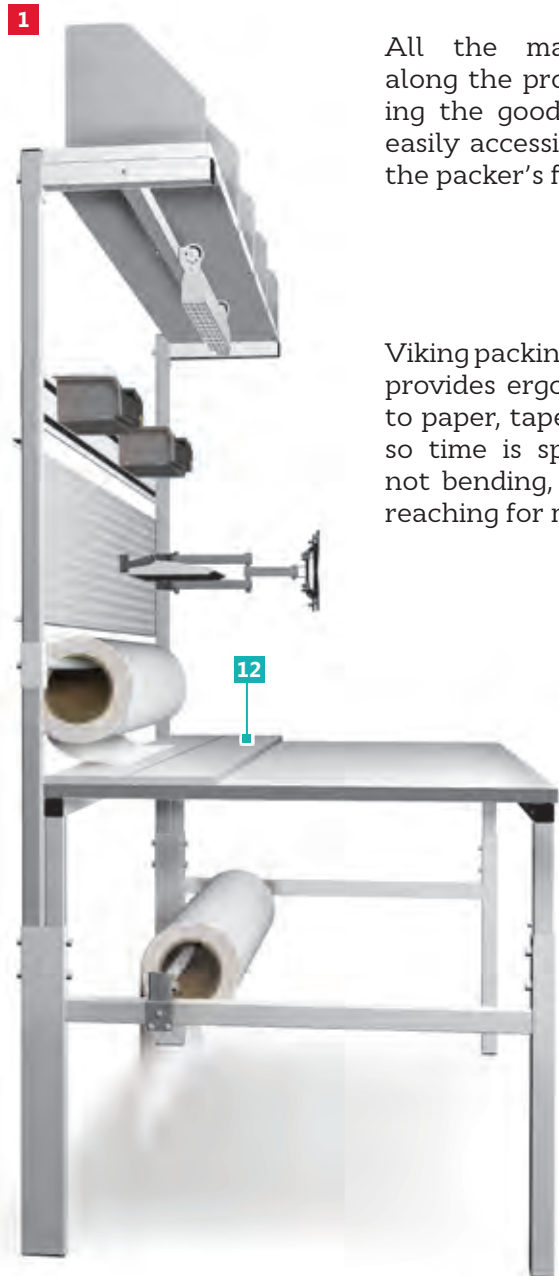
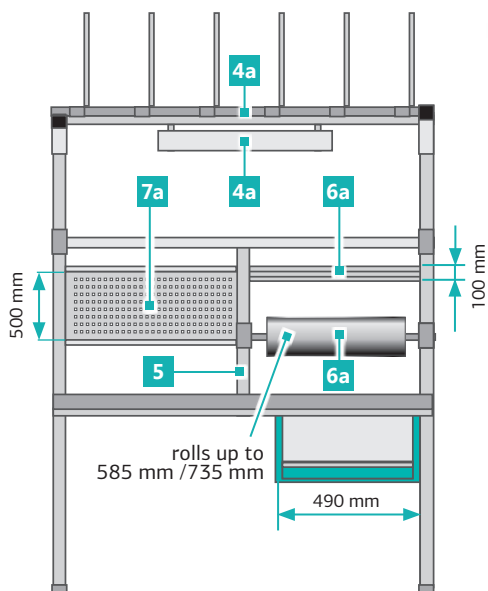
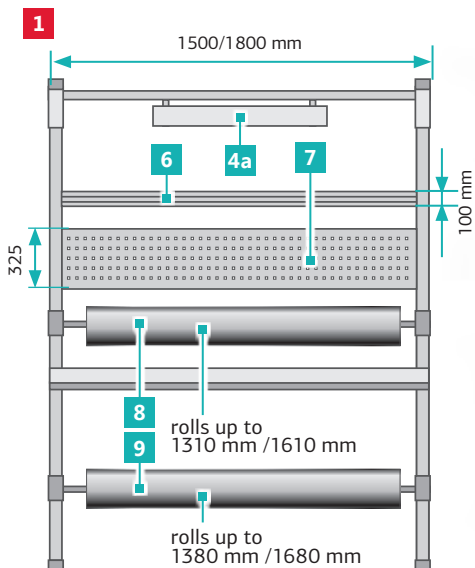

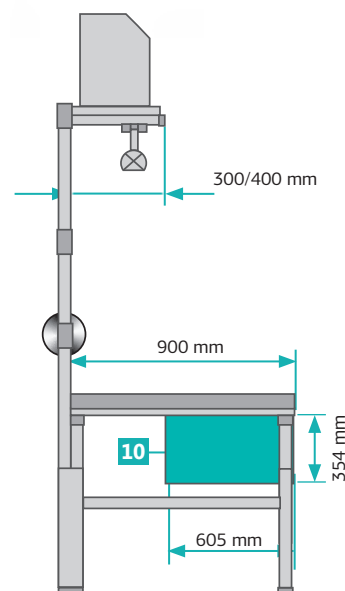

All the materials used along the process of packing the goods need to be easily accessible – right at the packer’s fingertips.

Viking packing workstation provides ergonomic access to paper, tape, and cartons so time is spent working, not bending, stretching or reaching for materials.









**1** Classic Workbench   



Basic part of Packing workstation. These workbenches can be placed in a line to make a common working area with no gaps. Universal design allows fitting out the workplace with necessary equipment and drawer units.



 650-900 mm  300 kg  300°C



**2** PO Main shelf  

Rear racks included.



 Height adjustment: 1000 — 1800 mm

 2 versions: 30 cm depth and 40 cm depth  50 kg

**3** EP Power panel  

**3a** 1/2 EP power panel  

Basic configuration consists of 4 sockets placed in aluminium case with protective contact and 3 m cable. Panel can be equipped with additional sockets, earth leakage circuit breaker, automatic fuse and a phone jack.

**4** DL/A Workbench lighting  

DL/A Workbench lighting is placed in an aluminum case with 2 energy-efficient luminescent 54 W lamps, light direction regulation and shadowless reflector provided. Quick switching on without shimmering, no strobing freeze.



- Length: 1200 mm
- Illuminance at 1000 mm distance: 1200 lux central



 500 mm -1350 mm.

**4a** DL/S2 Workbench LED lighting  

The case for lighting unit is made of aluminum, light direction regulation provided. Available in 2 versions: standard LED lighting, lighting with dimmer.

- Light source: LED lamps
- Light flux: 5985 Lm
- Power consumption: 43 W

 500 mm -1350 mm.  See more on p. 46.



**4b** DL/N2 Under-shelf local lighting  



Additional local LED lighting can be mounted to any workbench series Main Shelf and Perforated panel. Provides uniform illumination level. Available in 2 versions : 60 and 90 cm.

Also available with dimmer.  See more on p. 46.



**5** Middle upright for all kind of workbenches  

Middle upright is required for all 1/2 items, it consists of upright and transversal slat which differs according to workbench's width.



**6** RK Bin rail  

**6a** 1/2 RK Half-size bin rail  

Aluminum rail for bin storage placed along workbench length.

 10 kg  PK — 1410 / 1710×100 mm

 1/2 PK — 680 / 830×100 mm



**7** PFP Perforated panel  

**7a** 1/2 PFP Half-size perforated panel  

Panel can be equipped by different holders for additional equipment and tools storage.



 10 kg

 PFP— 1490 / 1790×325 mm, 1/2 PFP — 760 / 910×500 mm



**8** RD Upper rolls holder  

**8a** 1/2 RD Half-size rolls holder  

A holder that helps to locate rolls of paper, film or bubble wrap above the tabletop.  25 kg

**9** RD/2 Lower rolls holder  



A holder that helps to locate rolls of paper, film or bubble wrap below the tabletop.  25 kg

**10** TPP suspended cabinet for printer with sliding shelf  



Storage solution for printer or other equipment.

With lower sliding shelf.

 490×354×605 mm,  500×400×245 mm.

**11** D-PO shelves dividers  

Available in 2 versions: 300 and 400 mm deep.

**12** 1/2 PRM protective underlayer for cutting  

Half-size protective underlayer that helps to easily cut packaging materials not damaging the tabletop. To cover the overall worktop width one should order 2 pcs of protective underlayer.

 750/900×(305...309) mm

# CUSTOMIZED LAYOUTS

<https://viking-esd.com/forms/>

KNS Tabletop conveyor system 

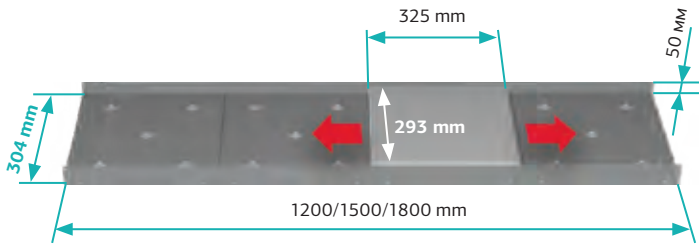



**VIKING** tabletop conveyor system allows to organize the simple conveyor transfer of equipment and materials between two or more workstations standing in a line, the system optimizes the electronics manufacturing workflow by speeding up the transfer of materials between several operators.



We are pleased to offer customized layouts based on our clients' individual requirements and projects. One can change size, shapes, add necessary elements to any particular module. **Minimum order quantity for customized layouts — 5 pieces.**



SR-VD workbench with movable middle unit



-  1800×700×825 mm (main workbench)
-  1100×500×825 mm (additional workbench)
-  30 kg

EM-SR-14 Workbench for electrical installation operations



-  1400×700×1920 mm
-  300 kg

We are pleased to offer customized layouts based on our clients' individual requirements and projects. One can change size, shapes, add necessary elements to any particular module

**Minimum order quantity for customized layouts — 5 pieces.**

ALF-N ALPHA series workbench with 3 aluminum supports and customized shape worktop



TTL-P Laboratory equipment transportation cart



TTU-N Heavy-duty transportation cart



# WORKPLACES ADDITIONAL EQUIPMENT

**KBK Cable channel**

Additional module for cables and wires, can be attached at the backside of the table or under the tabletop.

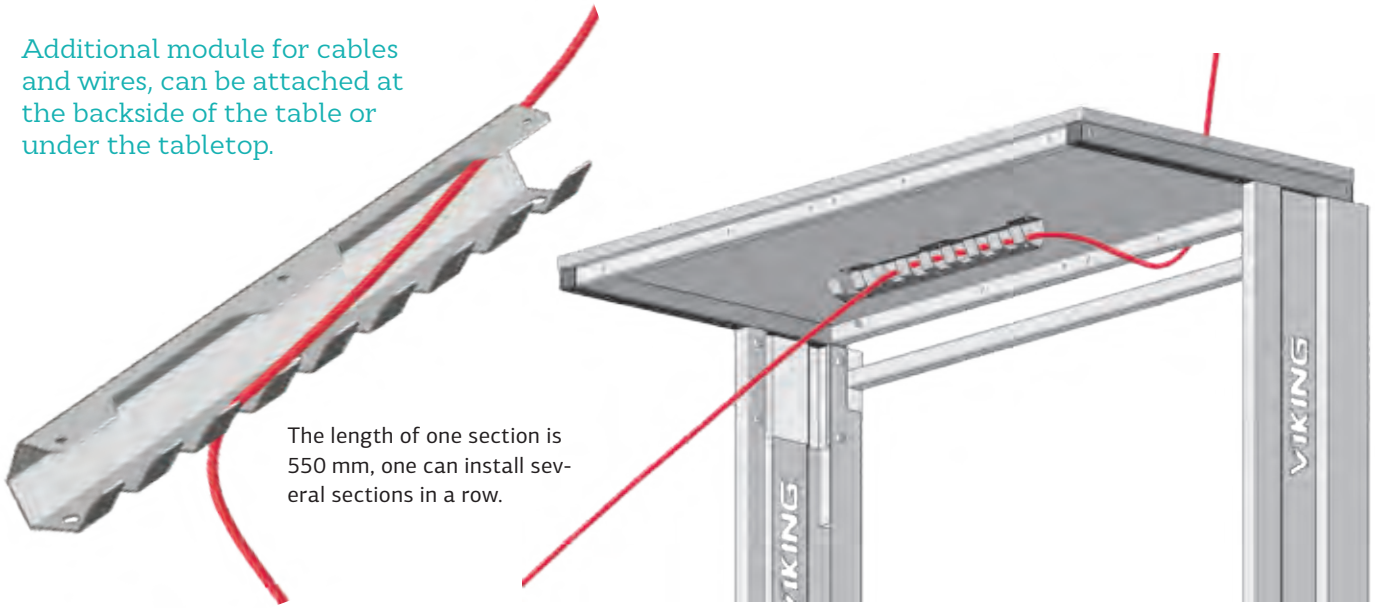

The length of one section is 550 mm, one can install several sections in a row.

**PPK-02 Metal keyboard support**



Telescoping metal support saves space on the tabletop. Keyboard support is produced of powder coated steel and available in dark grey (RAL 7012) or light grey (RAL 7035) colors. Keyboard support can be mounted to any workbench series which has enough space under the tabletop (minimum of 615 mm width and 383 mm depth is required).

616×135×383 mm plate for keyboard 245×505 mm  
 30 kg

**PPN-02 Footrest**



Footrest helps to provide workers with an ergonomically correct sitting position. PPN-02 footrest is equipped with height and angle adjustment mechanism.

400×300 mm

**KL-1200 Retracing mechanism**



**Should** be mounted to IP Cantilever module. Designed to suspend instruments and make them easy-to-reach. Cable tension depends on the weight of the instrument.

0.6–1.5 kg

**EP Power Panel accessories**



**Standard** power panels can be additionally equipped with a number of additional units:

- Single sockets with grounding
- USB double charger socket
- Double RJ 45 socket cat. 6UTP
- 10 A automatic fuse
- 16 A automatic fuse
- Circuit breaker

PPCH-01 (PPCH-01/GM, PPCH/A)  
Drafts holders



**Adjustable** drafts holder. Supplied in a set with two VIKING magnets. Requires PO Main shelf or Rear racks for SR series workbenches. Mounted to lateral supports for Gamma series. Rotary segments' length: 150 mm.



of metal plate 430×310 mm



15 kg

PPM-04 (PPM-04/A, PPM-04/GM)  
Monitor supports



**Adjustable** monitor holder. Requires PO Main shelf or Rear racks for SR series workbenches. Mounted to lateral supports for Gamma series. Rotary segments' length: 150 mm.



of metal plate 430×310 mm



15 kg

PPS-01 Movable computer case support



**Computer** support helps moving the computer case around the area.



220×150×480 mm

PPS-03 Suspended computer case support



**Suitable** for any VIKING workbench.



230×470×450 mm when folded, can be adjusted by screws

PPN-03/A Suspended footrest for ALLIANCE series workbenches

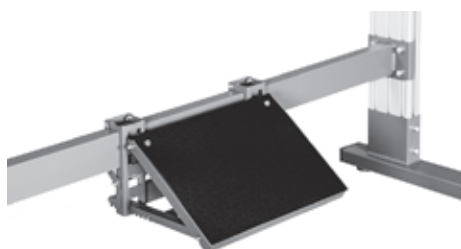

It is only suitable for ALLIANCE series workbenches. The footrest should be mounted to the lower slat and is equipped by a nonskid floor mat. 130° to 160° angle adjustment provides additional convenience for an operator.



of a platform 400×300 mm



60 kg

ARK Bin rail



Aluminum rail can be installed wherever on the wall to hold attached storage bins. Maximum length 3 m.

- Width 95 mm.

DL/N2 Under-shelf local lighting

Additional lighting can be mounted under the main shelf or attached to perforated panel. Suitable for any workbench equipped with upper modules. Angle adjustment  $\pm 60^\circ$  or  $80^\circ$  depending on the type of workbench.



- 2 versions: 60 cm length and 90 cm length
- Luminous flux: 3150/4725 Lm
- Color temperature 4700-5300 K

Provides at least 1000-lux illuminance at 1000 mm distance from the light source..

LED Lighting with dimmer

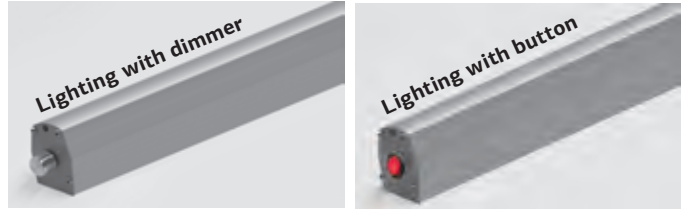

New models of upper workbench lighting and under-shelf lighting.

**New lighting matches all VIKING workbenches series:**

Classic, Comfort, Constant, Alliance, Alpha, Ostrov, Verstak, Sigma.

Material body: Aluminum, steel  
 Dimensions: 1200 mm, 900 (Alliance) mm – upper lighting  
 900 mm, 600 mm – under shelf version

Power connector: connection-C13/C14

Color temperature: 4700-5300 K

Illumination: DL/S2 – at a distance of 1000 mm  
 from the light source of at least 1200 Lux  
 DL/N2 - at a distance of 1000 mm  
 from the light source of at least 1000 Lux

Luminous flux: DL/S2 – 5000 lm  
 DL/N2-6/9- 4000 lm

PPT-01 Movable drawer unit support



Movable drawer unit support is an additional unit that helps to turn stationary drawer units and cabinets into movable one. It matches all standard cabinets (TMB-01/1 and TMB-02/1) and drawer units (DR-03/1, DR-05/1, DR-07/1 and DR-10/1). Four 50 mm casters, two of which are with brakes.

510x120x600 mm

350 kg



PO/K Reinforcing Bracket



A set of reinforcing brackets for main shelves of CLASSIC, COMFORT, CONSTANT and OSTROV series.

Helps to increase Main shelves load capacity up to 100 kg.

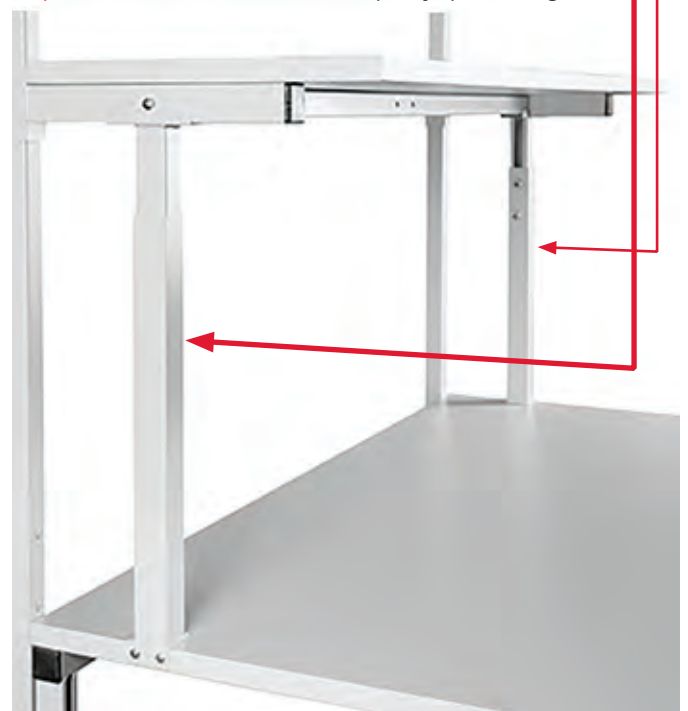

SNP Table-top lifting system



**Foldable** desktop system that allows setting one's computer, monitor or equipment at necessary height. Helps to organize the process of working in a standing position or periodically changing the position of an employee during the day.

**Load** capacity up to 3 kg. Self-locking mechanism in upper and lower position.

**Available** in two colors: light gray and dark gray and two versions: technical and ESD

786 × 392 × 60...286 mm

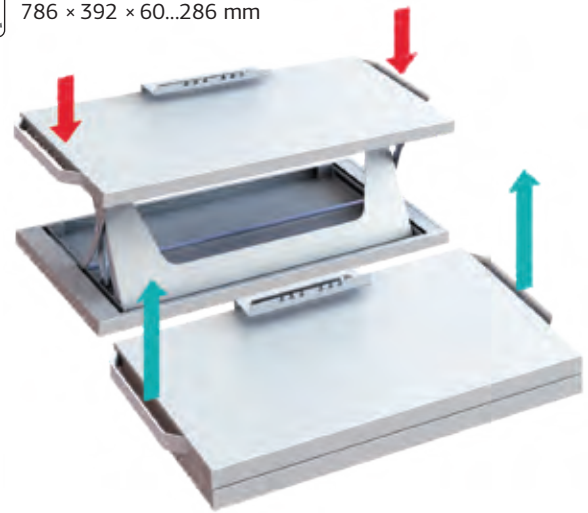

PFP Perforated Panel accessories

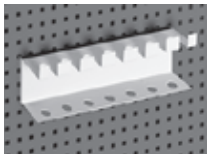
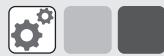

**K-01** Hook for tweezers and equipment with small handles.  
 174×70×40 mm

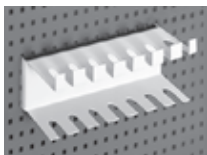

**K-02** Hook for screwdrivers.  
 174×70×40 mm

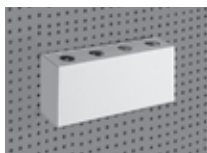

**K-03** Holder for pliers.  
 174×85×47 mm

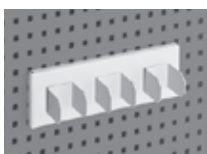

**K-04** Hook for any tools.  
 174×45×35 mm



**K-05** Holder for screwdrivers and 9–13 mm diameter drills.  
 175×100×32 mm



**K-06** Hooks for spanners.  
 188×181×52 mm



**K-07** Double hook for heavy instruments.  
 37×41×92 mm

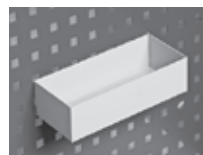

**K-08** Tray for small components and bottles.  
 174×45×82 mm



**K-09** Tray for A4-size papers.  
 311×45×225 mm



**K-10** A4-size papers holder.  
 233×289×30 mm



**K-11** Small aseptic and other bottles holder.  
 56×115×68 mm

# DRAWER UNITS

## SUSPENDED AND MOVABLE DRAWER UNITS



Steel frame drawer units are designed for tools and components storage. Movable and stationary drawer units can be also used as additional workplaces. Steel frame drawer units are equipped with central lock and either 550 mm telescoping drawers or shelves. Movable units have four rubber casters, two of which are with brakes. We also offer suspended drawer units with reduced to 490 mm depth, which allow installing various additional equipment under a tabletop.

Drawers' inner dimensions for different types are:

**A** — standard 400×45×505 mm    **B** — standard 400×100×505 mm

**C** — standard 400×160×505 mm    **D** — standard 400×200×505 mm

 per drawer 30 kg

Reduced drawers

**a** — reduced 400×45×426 mm    **b** — reduced 400×100×426 mm

DRAWER UNITS ↘	SUSPENDED				MOVABLE	
	TP-01/P	TP-02/P	TP-10/P	TP-20/P	TP-01/S	TP-02/S
Picture number	<b>1</b>	<b>2</b>	<b>3</b>	<b>4</b>	<b>5</b>	<b>6</b>
Dimensions (W×H×D), mm	490×354×605	490×233×605	490×354×490	490×233×490	490×580×610	490×650×635
Quantity of drawers	3	2	3	2	3	4
Drawers per unit	<b>A</b>	1	1	-	-	1
	<b>B</b>	2	1	-	-	2
	<b>C</b>	-	-	-	-	1
	<b>a</b>	-	-	1	1	-
	<b>b</b>	-	-	2	1	-
Weight (kg)	20	15	17	12	25	32

When ordering, please mention whether ESD or technical version, and whether dark grey RAL 7012 or light grey RAL 7035 color required.



# STATIONARY CABINETS AND DRAWER UNITS

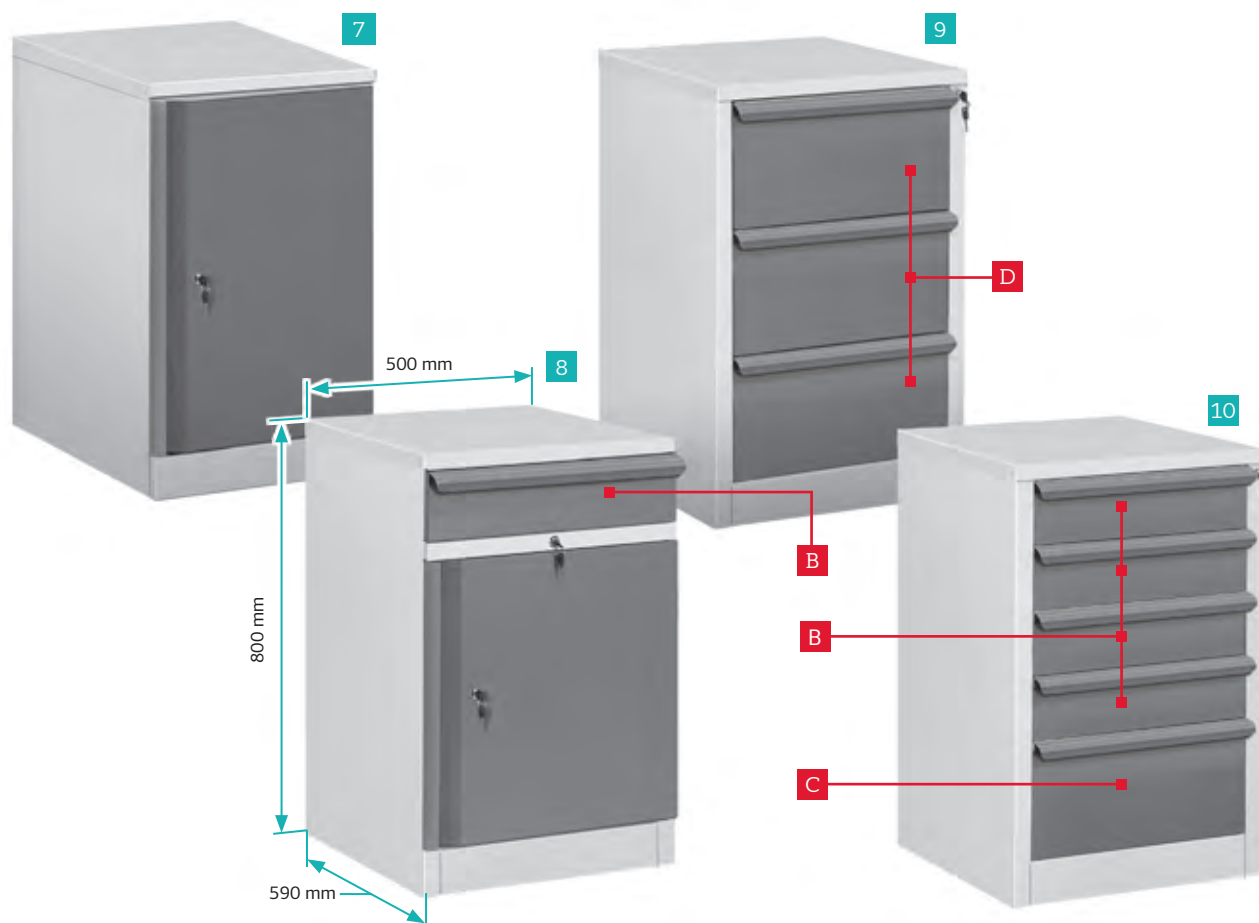

Steel frame stationary cabinets and drawer units are designed for tools and components storage and can be also used as additional workplaces. All stationary cabinets and drawer units can be installed as worktop supports for CONSTANT series workbenches and VERSTAK series technical workbenches. All standard stationary cabinets and drawer units are bicolored by default.

Drawers' inner dimensions for different types are:

- A** — standard 400×45×505 mm    **B** — standard 400×100×505 mm
- C** — standard 400×160×505 mm    **D** — standard 400×200×505 mm

 per drawer 30 kg

Stationary cabinets and drawer units have /1 in code if standing separately (for example, DR-07/1) and are indicated without additional number in code if used as VERSTAK or CONSTANT series support (for example VR-12+DR-03).

	STATIONARY			
	TMB-01/1	TMB-02/1	DR-03/1	DR-05/1
Picture number	7	8	9	10
Dimensions (W×H×D):	500×800×590 mm	500×800×590 mm	500×800×590 mm	500×800×590 mm
Quantity of drawers /shelves	2 shelves	1 drawer, 1 shelf	3 drawers	5 drawers
Drawers per unit	<b>B</b>	1	–	4
	<b>C</b>	–	–	1
	<b>D</b>	–	3	–
Weight (kg)	25	30	35	40

When ordering, please mention whether ESD or technical version required.

## ENLARGED CABINETS AND DRAWER UNITS



Steel frame enlarged stationary drawer units are designed for tools and components storage; can be also used as additional workplaces. DR-07/1 and DR-10/1 enlarged stationary drawer units are bicolored by default. For TMB-03/1 cabinet, please, mention whether dark grey RAL 7012 or light grey RAL 7035 color required. All cabinets and drawer units have /1 in code if standing separately (for example, DR-07/1).

Drawer's inner dimensions:

**A** — standard 400×45×505 mm **B** — standard 400×100×505 mm

**C** — standard 400×160×505 mm

	DR-07/1	DR-10/1	TMB-03/1
Picture number	1	2	3
Dimensions (W×H×D):	500×1040×590 mm	500×1520×590 mm	540×1050×500 mm
Quantity of drawers	7	10	2 closable sections
Drawers types per unit	<b>A</b>	2	1
	<b>B</b>	2	5
	<b>C</b>	3	4
Weight (kg)	55	75	20

## DRAWERS DIVIDERS

### Drawer dividers sets

Dividers help to organize drawer internal space according to specific needs.

One can modify the space to many cells according to the number and dimensions of items needed to store: instruments, PCBs, mounting elements or other items.

#### 1 D-10/A / DM-10/A sets

##### D-10/A



Dividers for type A standard drawers (400×45×505 mm).

##### DM-10/A

**Dividers** for type A reduced drawers (400×45×426 mm).

Each set consists of 4 longitudinal and 6 transversal dividers. Up to 35 different sized cells can be organized.

#### 2 D-11/B/ DM-11/B sets

##### D-11/B



Dividers for type B standard drawers (400×100×505 mm).

##### DM-11/B

**Dividers** for type B reduced drawers (400×100×426 mm).

Each set consists of 3 longitudinal and 4 big and 4 small profiled transversal dividers. Up to 10 different sized cells can be organized.

#### 3 D-16/B



Dividers for type B standard drawers (400×100×505 mm). The set consists of 4 longitudinal and 6 medium and 6 small profiled transversal dividers. Up to 15 different sized cells can be organized.

#### 4 KD/AB mat

ESD mat that should be ordered separately if drawers dividers set is being ordered for technical version cabinets. KD/AB mat is necessary to provide drawers dividers set stability and reliability.

#### 5 Additional equipment for drawers – plastic ESD trays

ESD inserts for components and personal belongings convenience storage are made to match standard type A and type B drawers. ESD inserts are produced of 2.2 mm thick black dissipative polystyrene. Max temperature 60°C.

Available in two versions:

- V-01 ESD, Antistatic inserts for type A standard drawers (400×45×505 mm). Insert contains 9 cells of different shape and dimensions: one 375×112 mm cell, four 182×112 mm cells, and four 86×112 mm cells.
- V-02 ESD, Antistatic inserts for type B standard drawers (400×100×505 mm). Insert contains 8 similar dimensions cells 112×182 mm each.



# HEAVY-DUTY MOVABLE WORKSTATION TM-03/04/05/06

1

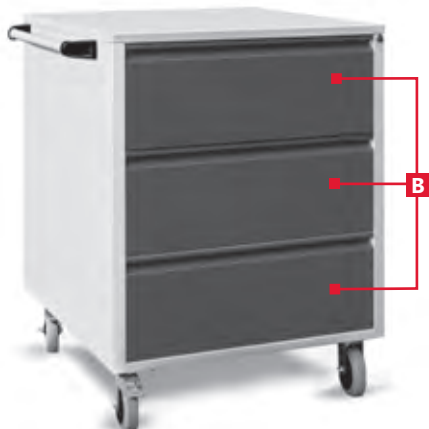

3



2

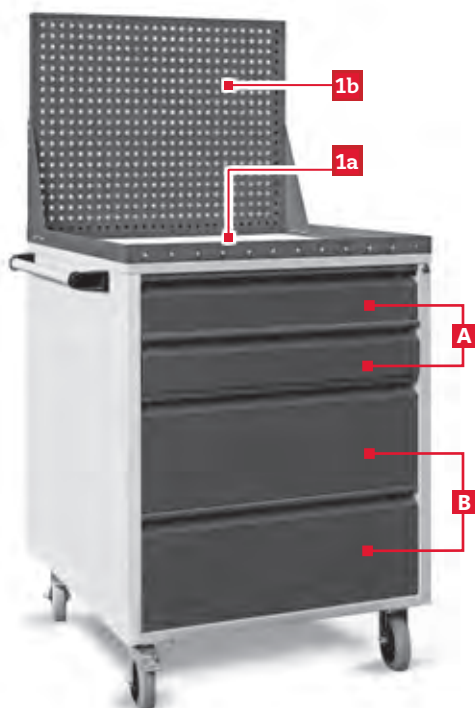

4



Heavy-duty movable workstation for accessories, metalworking tools and machine-building equipment storage, transportation and operational use.

Heavy-duty movable workstation is supplied in a set with reinforced wheels and lateral handle for movement.

Can be additionally equipped with:

- 1a** L-TM – Upper bin with upturns and anti-slip mat 800×40×600mm
- L-TM – Upper bin with upturns and anti-slip mat 800×40×600mm
- L-TM – Upper bin with upturns and anti-slip mat 800×40×600mm
- 1b** PFP-TM – Perforated wall 790×595×25mm.

The wall can be additionally equipped with K series holders.  
 Maximum load capacity for perforated panel – 50 kg.

Heavy-duty workstations of TM range are equipped with two types of drawers:

**A** 700×547×100 mm **B** 700×547×225 mm

	TM-03	TM-04	TM-05	TM-06
number of drawers	<b>1</b>	<b>2</b>	<b>3</b>	<b>4</b>
type of drawers	3 of <b>B</b> type	2 of <b>A</b> type 2 of <b>B</b> type	4 of <b>A</b> type 1 of <b>B</b> type	6 of <b>A</b> type

 800×800×600 mm,  per workstation 350 kg,  per drawer 45 kg

# MOVABLE TABLES AND CARTS

## MTT-01 MULTIFUNCTIONAL TRANSPORT TROLLEY



**1** MTT-01 Multifunctional transport trolley base

The set consists of a trolley base and 1 handle.  
**Wheels** set and additional options shall be ordered separately.  
**Load** capacity of the trolley is limited by load capacity of wheels set.

**Wheel sets for MTT-01 trolley**

- K-125 PBN 2 swivel casters without brakes + 2 non-swivel casters (load capacity up to 300 kg)
- K-125 PTP 2 swivel casters with brakes + 2 swivel casters without brakes (load capacity up to 300 kg)
- K-200 PTN 2 swivel casters with brakes + 2 non-swivel casters (load capacity up to 660 kg)
- K-200 PBN 2 swivel casters without brakes + 2 non-swivel casters (load capacity up to 660 kg)
- K-200 PTN 2 swivel casters with brakes + 2 swivel casters without brakes (load capacity up to 660 kg)

**2** MTT-R Handle

**3** MTT-U handle strengthening set (for one handle)

**3a** Set of connecting pads for bin cabinets.

**4** MTT-P Protective bars for trolley sides (set of 2)

**MTT pre-assembled kits**

**5** Multifunctional transport trolley with two tiers of modular bin segments SP-01 / C1 and SP-01 / S-2

**Multifunctional** transport trolley MTT is supplied either as a modular set where one can choose necessary option according to specific needs or as pre-assembled kits.

↑ Height: 1430 mm    ↓ Load capacity: 660 kg.

- Equipment:**
- base
  - MTT-R handles (2 pcs.)
  - MTT-U handle strengthening set (2 pcs.)
  - MTT-P Protective bars for trolley sides
  - K-200 PTP wheels set
  - bottom connecting pad
  - medium connecting pad
  - SP-01 / C1 Bin cabinet with 16 narrow bins (2 pcs.)
  - SP-01 / C2 Bin cabinet with 8 wider bins (2 pcs.)
  - cover.



**6** MTT / K-21 pre-assembled kit



**Multifunctional** transport trolley with side perforated panels.

↑ Height: 1100 mm

- Equipment:**
- base
  - MTT-R handle (2 pcs.)
  - K-125 PTP set of wheels
  - MTT-PB large perforated panel (2 pcs.)
  - MTT-PM small perforated panel (4 pcs.)



**1** Al-PS Alliance Movable table   



**6** PS-10 movable table with suspended drawer unit   



Movable table is used for tools and components storage and transportation. Equipped with four 75 mm casters, two of which are with brakes and three shelves, middle one with height's adjustment.

Movable table with TP-02/P suspended drawer unit can be used as additional workplace. Movable table is equipped with four 75 mm casters, two of which are with brakes.

 515×780×710 mm  150 kg

 650-890 mm

 upper shelf 515×700 mm  
 middle shelf 420×700 mm  
 lower shelf 355×700 mm



**2 3 4** PS-07, PS-10, PS-15 movable tables **5** PS-07 Comfort   

Movable tables are used for tools and components storage and transportation. All movable tables are equipped with four 75 mm casters, two of which are with brakes.



 650-890 mm (PS-07, PS-10, PS-15)  705-950 mm (PS-07 Comfort)

CODE	PS-07	PS-10	PS-15	PS-07 COMFORT
Picture number	<b>2</b>	<b>3</b>	<b>4</b>	<b>5</b>
Load capacity per surface		150 kg		100 kg
Dimensions, W×D	710×515 mm	700×1000 mm	700×1500 mm	710×515 mm
Inner dimensions and usable area of upper shelf	515×710 mm	700×1000 mm	700×1500 mm	515×710 mm
Inner dimensions and usable area of lower shelf	410×710 mm	610×1000 mm	610×1500 mm	410×710 mm







**7** GM-PS Gamma movable table  

Movable table is used for tools and components storage and transportation. Equipped with four 75 mm casters, two of which are with brakes and three shelves.

 570x910x700 mm  overall up to 200 kg  lower shelf up to 100 kg

For ESD version with turquoise (RAL 5021) edges, for technical version - with light gray edges. Shelves are not height adjustable. Can be additionally equipped with EPA-PS-GM power panel on the back side.

  upper shelf 570x700 mm  
middle shelf 420x700 mm  
lower shelf 415x695 mm

**8** **9** **10** TT-02, TT-03, TT-04 transportation carts  



**Transportation** carts are used for tools and components storage and transportation. Metal carts are equipped with four 75 mm (for TT-02, TT-03 carts) or 125 mm (for TT-04 cart) casters, two of which are with brakes, and height adjustable shelves.

CODE	TT-02	TT-03	TT-04
Picture number	<b>8</b>	<b>9</b>	<b>10</b>
Dimensions (W×H×D):	470×990×840 mm	470×990×840 mm	615×1560×1270 mm
Quantity of shelves	2	3	4
Inner dimensions of a shelf	465×665 mm	465×665 mm	615×1270 mm
Usable area per shelf	405×605 mm	405×605 mm	555v1210 mm
Shelves height adjustment	140–800 mm	140–800 mm	165-1465 mm
Load capacity (kg)	100 kg	100 kg	100 kg





When ordering, please mention whether ESD or technical version, and whether dark grey RAL 7012 or light grey RAL 7035 color required.

# MOVABLE TROLLEYS



**1** AL-ST Equipment trolley   

**Equipment** trolley is designed for additional equipment storage and transportation. It has five height adjustable shelves and a half-size power panel with four sockets and a switch. The panel is located on the side frame thus does not occupy any space on shelves. Equipment trolley side frames are manufactured of aluminum profile, which allows attaching small elements, and gives the whole unit elegant look. Trolley has four casters, two of which are with brakes as supports.





-  463×693×1940 mm
-  150 kg
-  lower shelf 460×535 mm
-  four upper shelves 400×600 mm



**2** ST-05 Movable trolley **3** ST-05 Comfort Movable trolley   

**Movable** trolleys are used for tools and components storage and transportation.

Each trolley is equipped with five height-adjustable shelves and a power panel with five grounded and one ungrounded socket, and four casters, two of which are with brakes. Lateral position of power panel.





CODE	ST-05	ST-05 COMFORT
Dimensions, W×H×D	600×510×1640 mm	700×470×1635 mm

-   lower shelf 460×600 mm
-  150 kg
-  four upper shelves 400×600 mm

**4** ST-06 Movable trolley   



**Movable** trolley is used for tools and components storage and transportation.

**Trolley** is equipped with five height-adjustable shelves and four casters, two of which are with brakes. No power panel included.

-  600×1605×500 mm
-  150 kg
-  per shelf 50 kg
-  shelf 500×600 mm
-  for each shelf 420×520 mm













5 GM-ST Gamma movable trolley  

**Movable** trolley is used for tools and components storage and transportation. Equipped with 5 shelves and a built-in power panel with 5 sockets and a switch.

**Four** 75 mm casters, two of which are with brakes.



-  750×1960×600 mm
-  200 kg
-   lower shelf 592×592 mm
-  Each shelf 200 kg
-   middle shelves 600×500 mm

6 SKM Dual movable trolley 

**Dual** Movable trolley for accessories is made of a rack coated with conductive powder paint, thus available only in ESD version. Lower shelf made of ESD laminated chipboard 25 mm thick. Trolley is equipped with four 75 mm casters (2 of them with brakes) and six rails for boxes. Attachable bins should be ordered separately.

**Each of 2 sides of bin rails can be additionally equipped with:**





- 6 pcs of COCIS-A
- 6 pcs of COCIS-B
- 4 pcs of COCIS-C
- 3 pcs of COCIS-E

-  680×1600×460 mm
-  100 kg

7 ST-VR-01 Movable equipment trolley 



**Convenient** equipment trolley with side handle allows tools and equipment storage on upper perforated panel and two lower shelves. **All** standard hooks (K-01–K10) can be mounted to upper perforated panel.

**Movable** trolley equipped with four casters, all with brakes.

-  885×1550×700 mm
-  shelves 690×698 mm
-  per trolley 250 kg
-  per shelf 100 kg
-  665×695 mm

8 ST-R Movable repairing trolley 



**The** trolley is equipped with two-sided 525×600 mm perforated panel above the trolley's tabletop and a drawer unit with five telescoping drawers lower.

-  of the trolley 600×1730×630 mm
-  of the drawer 500×800×590 mm
-  for perforated panel 10 kg

9 SUS Movable packing trolley 

**Auxiliary** trolley, designed for convenient polyethylene, damping film, paper and other packaging materials rolls clamping; maximum roll's width — 1.5 m.

**Movable** packing trolley equipped with four 50 mm casters, all with brakes.

-  1240×600×1800 mm
-  80 kg

# CABINETS AND WARDROBES



All cabinets have central lock.

Filing and combined cabinets have three or four height adjustable shelves with 50 mm pitches.

For wardrobe and combined cabinets garment bar included.

For SHDZH Sliding shutters cabinets inner dividers included.

For SHKH cabinets 16 (SHKH-2) to 30 (SHKH-1) 360 mm telescoping drawers with inner dimensions of 310×100×360 mm included.

 per surface — 30 kg

PICTURE NUMBER	CODE	DIMENSIONS (W×H×D), MM	WEIGHT, KG
SHD-1, SHD-2, SHD-3 Filing cabinets			
1a	SHD-1	1000×1950×550	80
	SHD-2	820×1850×450	62
1b	SHD-3	820×1000×450	40
SHO-1, SHO-2 Wardrobe cabinets			
2	SHO-1	1000×1950×550	68
	SHO-2	820×1850×450	52
SHK-1, SHK-2 Combined cabinets			
3	SHK-1	1000×1950×550	78
	SHK-2	820×1850×450	58
SHKH-1, SHKH-2 Drawers cabinets			
4	SHKH-1	820×1850×450	127
	SHKH-2	820×1060×450	69

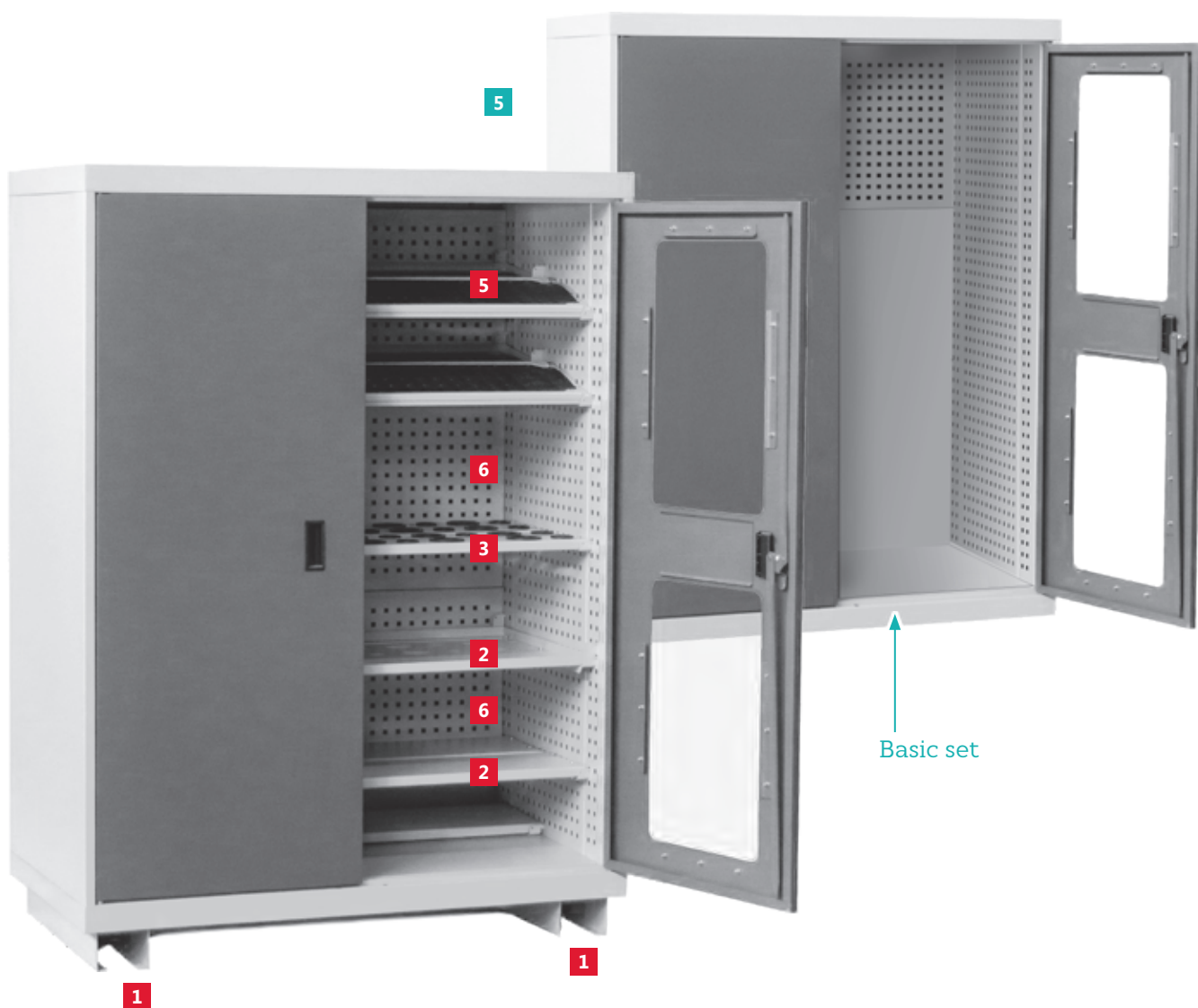

5 SHH-O modular tools cabinet   

**Heavy-duty** modular cabinet for accessories, metalworking tools and machine-building equipment.

The cabinet is equipped with two doors (one metal blank and one with a window of polycarbonate), a lock and

an internal perforated wall, allowing to place K series hooks inside the cabinet  p. 47

Cabinet allows installing additional equipment:

- 1 HN-SHH-O** runners that allow the cabinet movement with a forklift.
- 2 P-SHH-O** Full-size blind shelf that can be installed inside the cabinet.
- 3 TT-P/VT** Half-size shelf with tool storage system for reliable fixation of milling, drilling and CNC lathes tools. Two types of perforation (30 mm and 56 mm in diameter) with protective plastic inserts.
- 4 TT-B/VT** Half-size shelf with anti-slip rubber and upturns
- 5 TT-K/VT** Half-size shelf with anti-slip rubber.
- 6 PFP-SHH-O** additional perforated panel that can be installed to the back wall of the cabinet.

 1080×1400×600 mm  per cabinet 1200 kg  per shelf 100 kg  per perforated panel 30 kg

6 SHDI-1 Tool cabinet



The cabinet is equipped with 5 pull-out drawers with internal dimensions 435/2×125×525 mm.

The metal two-door cabinet SDI has a CAM LOCK type lock with pull rods, security is 2000 combinations.

 530×1400×605



 The load on each drawer is up to 30 kg



7 SHO-3 Two-section garment wardrobe



Two-section garments wardrobe is equipped with four shelves (two for each section), 2 rods with hooks for garments and additional perforation that provides ventilation of the inner zone.

 600×1750×500 mm  59 kg

8 D-6/SH



Dividers for type SHKH drawers (360×100×310 mm). The set consists of two longitudinal and four transversal dividers. Up to 15 different sized cells can be organized.

9 KD/SH mat

ESD mat that should be ordered separately if drawers dividers set is being ordered for technical version cabinets. KD/SH mat is necessary to provide drawers dividers set stability and reliability.



7

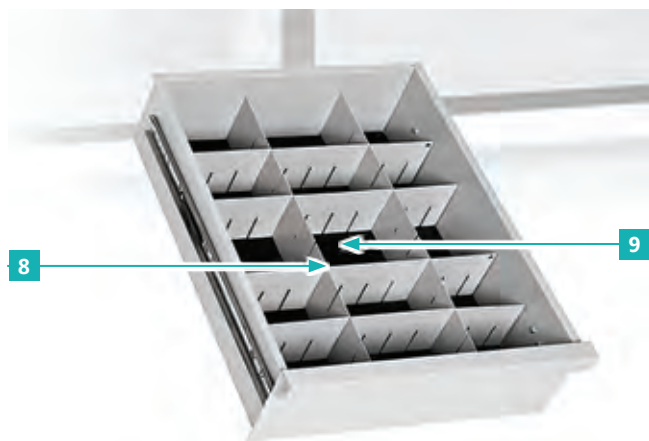

8

9

# SHELVINGS





3



4



5

3, 4 STU Shelving   

Shelving is used for documents and components storage. Shelvings (except for the STU-01) have height-adjustable supports and five height adjustable shelves with 50 mm pitches.



For STU-01 there are six height adjustable shelves with 50 mm pitches.

 per shelf — 30 kg  per unit — 180 kg for STU-01

 per unit — 110 kg for STU-05

Nº	CODE	Dimensions, mm
3	STU-01	820×1850×450
4	STU-05	1000×1950×490



When ordering, please mention whether ESD or technical version, and whether dark grey RAL 7012 or light grey RAL 7035 color required.

5 STS Reinforced shelving   

Height-adjustable supports. Four height adjustable shelves with 50 mm pitches. No additional floor leveling required.

 per shelf - 350 kg  per unit - 800 kg

Nº	CODE	Dimensions, mm
5	STS-12	1200×1800×600
	STS-15	1500×1800×600

PL-1, PL-2, PL-ST5-12, PL-ST5-15     
Additional shelves

Additional shelves for cabinets and shelving

SHELF	TO BE USED FOR
PL-1	SHD-1, STU-05
PL-2	SHD-2, SHD-3, STU-01
PO-ST5-12	STS-12
PO-ST5-15	STS-15

# MODULAR COUNTERS

## MODULAR TURNTABLE COUNTER

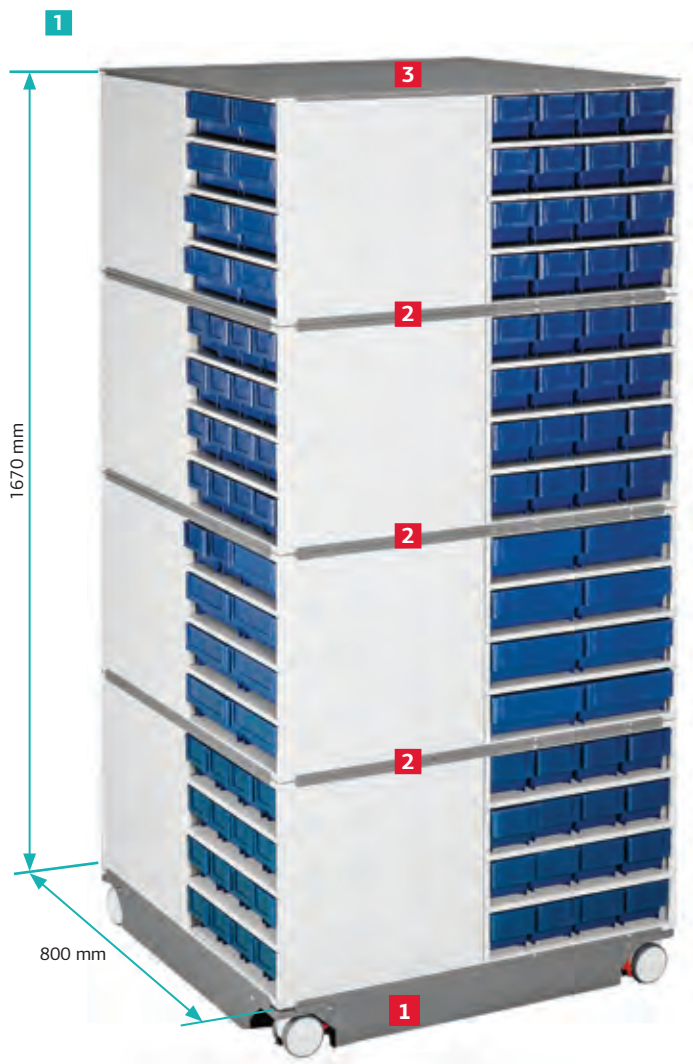

2



3



4



Turntable modular storage counter is a practical and high-capacity solution for components and tools keeping, that provides convenience of its usage in different production processes.

Turntable modular counter is equipped with bin cabinets containing two types of plastic bins: narrow and wide.

- **narrow** bins with up to of 2.4 liter volume



- **wide** bins with up to 4.3 liters volume

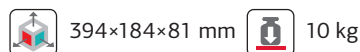

Turntable modular storage counter can be ordered as a complete set or partially.

Modular storage counter in ESD version contains black antistatic plastic bins.

### 1 SP-01

Full modular counter set consists of eight bin cabinets, each with 16 narrow bins and eight bin cabinets, each with 8 wide bins and technical connecting/turntable set. Full modular counter set is easily assembled of 16 bin cabinets placed in four levels, whereas each level contains four bin cabinets.



### 2 SP-01/S-1

Bin cabinet with 16 narrow bins.

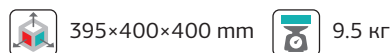

### 3 SP-01/S-2

Bin cabinet with 8 wide bins.

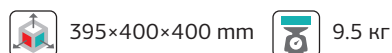

### 4 SP-01/K

Technical modules set that consists of

- 1** — turntable base,
- 2** — 3 connecting pads,
- 3** — top lid.

SP-01/S-1, SP-01/S-2 and SP-01/K modules are necessary to built up a customized modular set.

Standard SP-01 set includes technical pads, base and top lid.

**When ordering, please mention whether ESD or technical version required.**

# MODULAR STATIONARY COUNTER

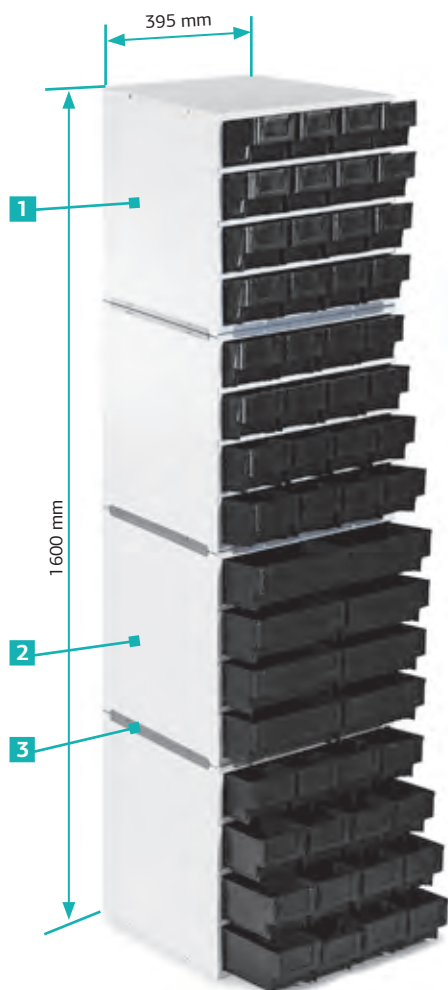

**Stationary** modular storage counter is a practical and compact solution for components and tools keeping, that can be placed anywhere in production hall.

**Stationary** modular counter is equipped with bin cabinets containing 2 types of plastic bins: narrow and wide.

- **narrow** bins with up to of 2.4 liter volume



- **wide** bins with up to 4.3 liters volume

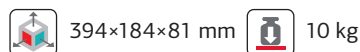

**Modular** storage counter in ESD version contains antistatic plastic bins.

**Stationary** modular storage counter is ordered in parts, bin cabinets and technical connecting pads separately. Maximum of 4 bin cabinets can be placed in a column.

## 1 SP-01/S-1

Bin cabinet with 16 narrow bins.

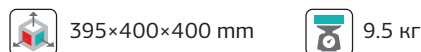

## 2 SP-01/S-2

Bin cabinet with 8 wide bins.



## 3 SP-01/PM

Connecting pad for bin cabinets.

**Ordered** if several bin cabinets need to be placed on one another to provide safer junction.

## 4 SP-01/C-1/D Dividers for narrow cases of the modular counter

They allow dividing the space inside a case. Max. 6 dividers can be places in one case.

## 5 SP-01/C-2/D Dividers for wide cases of modular counter

The allow dividing the space inside a case. Max. 6 dividers can be placed in one case.

## 6 SP-01/PPT Movable modular counter support

**Movable** modular counter support is designed to provide the mobility to modular counters. It has 4 casters with 50 mm diameter, 2 of which are with brakes. The stand can sustain 4 drawer units, which are established at each other.

4

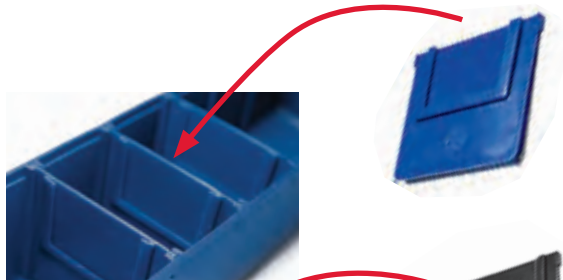

5



6



# DRY STORAGE CABINETS



1

2

3

DC ESD series dry storage cabinet is a line of special equipment designed to provide ultra-low ranges of relative humidity, which is necessary for handling moisture-sensitive components and materials including precision metal parts, printed circuit boards, plates, nano fibers, cassettes, laboratory samples, electronic modules.

All DC ESD series cabinets produced only in antistatic (ESD) version, in strict compliance with ESD safety regulations of IEC 61340-5-1. For dry storage cabinets we use only specific ESD glass with conductive surface (conductivity  $10^3 - 10^5$  Ohm) and ESD wheels. All the shelves and horizontal surfaces of the cabinet are grounded and ESD coating of all metal elements is applied.

All cabinets are supplied in a set with one middle standard or shortened shelf for each section. All cabinets except for 1-section version are supplied in a set with ESD wheels. Each section has a separate key.

DC ESD series dry storage cabinets feature low noise level and equipped with temperature and humidity levels indication and door alarm system.

CODE	DC-1 ESD	DC-2 ESD	DC-3 ESD	DC-4 ESD	DC-6 ESD
Picture number	1	2	3	4	5
Number of doors	1	2	3	4	6
Dimensions, W×H×D, mm	600×737×640	600×1342×640	600×1947×640	1205×1342×640	1205×1947×640
Capacity, liters	238	454	670	900	1340
Weight, kg	58	100	131	160	227
Number of standard shelves in default version of the cabinet <b>A</b>	0	1 <b>A</b>	2 <b>A</b>	2 <b>A</b>	4 <b>A</b>
Number of shortened shelves in default version of the cabinet <b>a</b>	1 <b>a</b>	1 <b>a</b>	1 <b>a</b>	2 <b>a</b>	2 <b>a</b>
Max. recommended quantity of shelves per cabinet ( <b>A</b> , <b>a</b> )	2 <b>a</b>	1 <b>A</b> 3 <b>a</b>	3 <b>A</b> 3 <b>a</b>	4 <b>A</b> 4 <b>a</b>	6 <b>A</b> 6 <b>a</b>

All DC series cabinets are equipped with **RS-232** that allows data collection. One should simply connect DC dry cabinet to a computer using standard cable.

DC series cabinets feature humidity & temperature display with parameter value input on easy-to-operate three buttons digital control LCD-panel.

**Humidity** and temperature monitoring is performed by the built-in precision sensor with digital interface, processor and LCD display. Monitoring is performed by a sensor, based on CMOS technology, each sensor is being factory calibrated prior to installation.

DC ESD series dry cabinets are available in:

- White**     **RAL 9010** (code DC-W ESD, for example DC-3W ESD for 3-doors white cabinet)
- Light grey**     **RAL 7035** (code DC-G ESD, for example DC-6G ESD for 6-doors grey cabinet)
- Black**     **RAL 9005** (code DC-B ESD, for example DC-1B ESD for 1-door black cabinet)



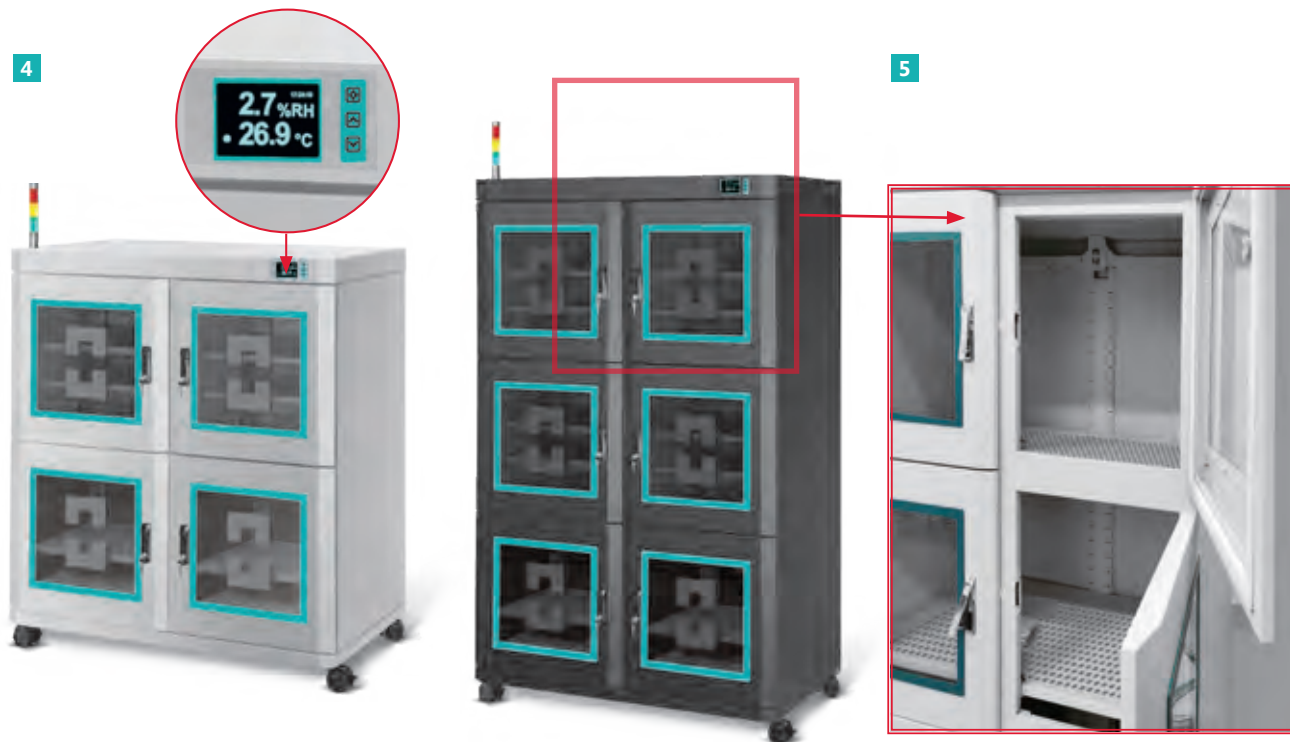

TECHNICAL SPECIFICATIONS	VALUE
Humidity range	1-50%
Precision	±1%
Absorption of moisture	automatically regenerated absorbent (Zeolite)
Max. dimensions of units to store	Width up to 500 mm, Heights up to 510 mm, Depth up to 570 mm*
Door alarm	integrated
Supply voltage	220 ± 22 V
Max. power consumption	
Storage phase	20 watt/hour for DC-1, DC-3, DC-3
	30 watt/hour for DC-4, DC-6
Regeneration phase	210 watt/hour for DC-1, DC-3, DC-3
	240 watt/hour for DC-4, DC-6
IP protection class	IP 55

\* separate numbers for each dimension

## DESICCATION AND RECOVERY TIME

**Recovery Time** – is one of the most critical performance parameters of any dry storage cabinet, it refers to the time required for the cabinet to reduce the RH level back to its set point after the door been opened and closed.

CODE	DC-1	DC-2	DC-3	DC-4	DC-6
Desiccation time, mins					
from 50% to 1% RH	45	96	100	75	80
from 50% to 5% RH	12	55	60	37	40
Recovery time for humidity level after the door been opened and closed, mins					
up to 10% RH after opening the door for 10 sec*	3	3	4	1	1
up to 5% RH after opening the door for 10 sec*	7	7	8	3	3
up to 3% RH after opening the door for 10 sec*	13	14	15	6	7
up to 1% RH after opening the door for 10 sec*	16	23	25	12	13
up to 0.1% RH after opening the door for 20 sec*	19	32	35	16	18
Number of cabinet door openings per hour					
at a set relative humidity level of 3%*	4	4	3	8	7

\* Test measurements were carried out without containers inside an empty cabinet, at a relative humidity of 50% RH and a temperature of 25 °C

## ADDITIONAL EQUIPMENT

- 1** Swivel supports (to replace casters)
- 2** C-DC Light tower
- 3** SHW-DC/ SHG-DC/ SHB-DC Additional shelves
- 4** SHB-SH-DC/ SHG-SH-DC/ SHW-SH-DC Additional shortened shelves
- 5** DC-A2-B/DC-A2-W/DC-A2-G Automatic nitrogen unit
- 6** DC-AW, DC-AB, DC-AG Manual nitrogen unit
- 7** SCO-W-DC/SCO-G-DC/SCO-B-DC Reels adjustable rack
- 8** LIW-DC/LIB-DC/LIG-DC Shelves limiters
- 9** VHM software
- 10** LED-DC Inner LED indicative lighting (5 types)
- 11** USC-DC/USS-DC Sliding shelves
- 12** USB-DC, optional USB port
- 13** SE-DC shelves separators

**8** LIW-DC/LIB-DC/LIG-DC Shelves limiters



**Mounted** on a standard dry storage cabinet shelf. Limits the inner space of the shelf for components storage. Can be installed in both positions – along and across the shelf.

Available in:

- White** RAL 9010 (code LIW-DC)
- Light grey** RAL 7035 (code LIG-DC) or
- Black** RAL 9005 (code LIB-DC)

**9** VHM software

**VIKING** humidity manager is a user-friendly software that helps the operator to be aware of the storage conditions; records dry cabinet data and allows checking the graphs over a period of time.

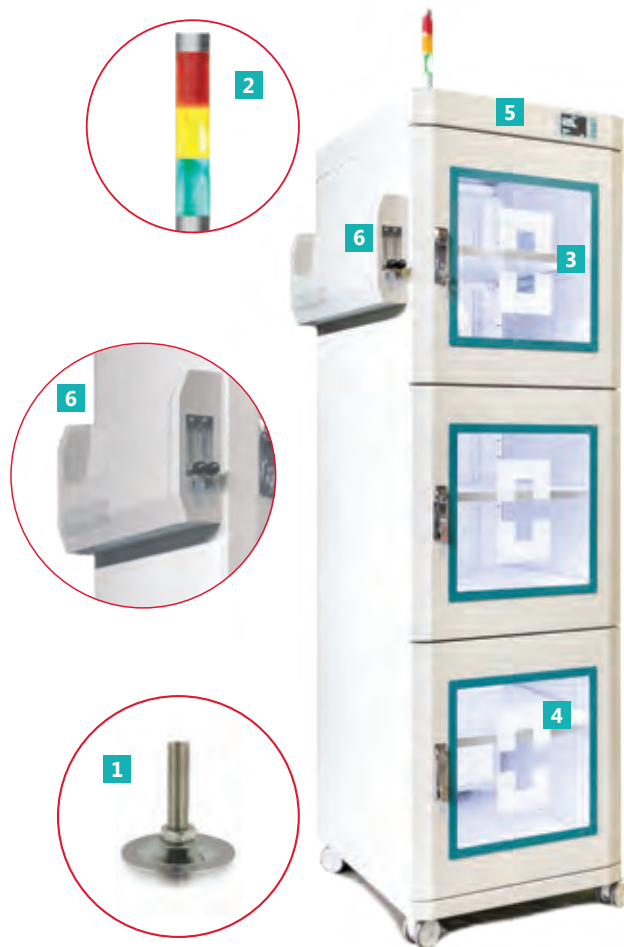

**7** SCO-W-DC/SCO-G-DC/SCO-B-DC SMD Reels adjustable rack



**SMD Reels adjustable Rack** is mounted on a standard dry storage cabinet shelf. Allows organizing three rows for 82-215 mm diameter SMD reels. Minimum width of each cell is 27 mm.

Available in:

- White** RAL 9010 (code SCO-W-DC)
- Light grey** RAL 7035 (code SCO-G-DC) or
- Black** RAL 9005 (code SCO-B-DC)

10 LED-DC Inner LED indicative lighting

indicative lighting helps to quickly check the cabinet's current status:

- **Green** – indicates the cabinet proper functioning and targeted relative humidity/O2 level,
- **Yellow** – cabinet is in recovery mode (for example, after opening the door),
- **Purple** – the cabinet is working in nitrogen supply mode before reaching O2 level,
- ⊠ **Flashing red** – when the door is being opened for more than 30 sec,
- **Red** – reports critical errors in cabinet operation,
- **Cold white** – when opening the door or when changing the cabinet settings.



11 USC-DC/USS-DC Sliding shelves



**Sliding** shelf is a kit containing two sections with sliding mechanism, upper section is equipped with upturns for components and assemblies' storage, lower section is a narrow case for documents storage.

13 SEW-DC/SEB-DC/SEG-DC shelves separator



**SE** Shelf separator fits any standard/shortened shelf of dry storage cabinet, allows to divide the space inside the cabinet. **Separator** size 100 × 550 mm

DC ESD dry cabinets meet or exceed international standards:

- IPC / JEDEC J-STD 033C «Handling, Packing, Shipping and Use of Moisture/Reflow Sensitive Surface Mount Devices»;
- IPC / JEDEC J-STD-020C «Moisture/Reflow Sensitivity Classification for Nonhermetic Solid State Surface Mount Devices»;
- EIA / IPC / JEDEC J-STD-075 «Classification of Non-IC Electronic Components for Assembly Processes».

## SIMPLIFIED VERSIONS OF DC DRY STORAGE CABINETS LINE



**VIKING**

**DC Light** DCL-3 ESD, DCL-6 ESD are 3-sections and 6-sections simplified and more affordable versions of DC dry cabinets product line. The Light line also includes DCLN-3G ESD unit with automatic nitrogen supply equipment.

They provide ultra-low ranges of relative humidity and quick recovery.

**DCL-3G ESD** and **DCL-6G ESD** series 6-sections dry storage cabinet allows handling moisture-sensitive components and materials in 3 / 6 sections. Shelves of a 6-sections cabinet can be installed in a checkerboard order, each two horizontally located sections have joint non-separated space.

The **DC Light** series cabinets have the same excellent technical specifications as the main line of DC dry storage cabinets: maintaining the precise humidity level and quick dehumidification, but feature a simpler lightweight frame and fewer additional features and options.



CODE	DCL-3 ESD	DCL-6 ESD
Recovery from 50% to 1% RH	100 min	80 min
Recovery from 50% to 5% RH	60 min	40 min
Average time to recover humidity to 10% RH after 10 sec door opening *	4 min	1 min
Average time to recover humidity to 5% RH after 10 sec door opening *	8 min	3 min
Average time to recover humidity to 3% RH after 10 sec door opening *	15 min	7 min
Average time to recover humidity to 1% RH after 10 sec door opening*	25 min	13 min
Average time to recover humidity to 1% RH after 20 sec door opening *	35 min	18 min

\* - the experiment was carried out without containers inside the dry cabinet, at 50% RH relative humidity and a temperature of 25 °C

**DCL** ESD models supplied with a grounding cord that should be connected to the ground at the breaker box after installation of the cabinet. The front panel of the Viking DC Light dry storage cabinet has a button to attach grounding strap.

**DC** light dry storage cabinets are only available in light gray (RAL7035).

**DC** light series dry storage cabinets are equipped with audible signaling of the cabinet doors opening, it works when one of the DC cabinet doors are being opened for more than 30 seconds.

**Control** panel with a monochrome graphic display and three control keys is located on the top front side of the cabinet.

**DC** light cabinets are equipped with an RS-232 port, providing the possibility to connect the cabinet with a PC and use VIKING Humidity manager software.

### Additional equipment

- C-DC Light tower
- SHG-DC Additional shelves
- SHG-SH-DC Additional shortened shelves
- SCO-G-DC Reels adjustable rack
- LIG-DC Shelves limiter
- VHM software
- SEG-DC shelves separator



### Technical specifications

CODE →	DCL-3 ESD	DCL-3 ESD	DCLN-3 ESD
Number of sections	3	6	3
Number of shelves in a set	2 standard 1 shortened	4 standard 2 shortened	3 standard
Load capacity per shelf, kg	45		
Capacity, liters	670	1340	670
Weight, kg	103	182	103
Depth, mm	640		
Width, mm	600	1205	600
Height (with wheels, without wheels)	2023/1947		
Humidity range	1-50%		
Precision	±1%		

LIG-DC Shelves limiter



SCO-G-DC Reels adjustable rack

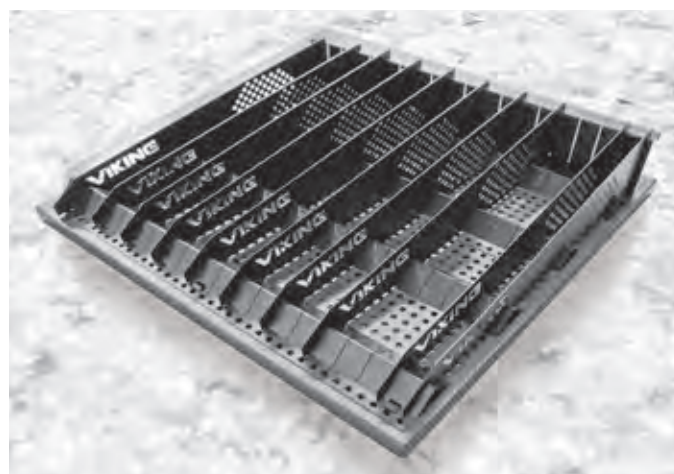

# ESD CHAIRS

VKG C-100 ESD



**AESD** laboratory chair, covered with static dissipative fabric, can be equipped with five conductive glides or five ESD casters. Can be also equipped with KT type ESD armrests, footrest and enlarged gaslift on request.

- Back angle adjustment
- Seat height adjustment: 43-63 cm
- Available colors: grey and blue



VKG C-200 ESD



**ESD** laboratory chair, covered with static dissipative fabric, can be equipped with five conductive glides or five ESD casters. Can be also equipped with KT type ESD armrests, footrest and enlarged gaslift on request.

- Back and seat angles adjustments
- Seat height adjustment: 43-63 cm
- Available colors: grey and blue



VKG C-300 ESD



**ESD** laboratory chair with conductive incombustible polyurethane upholstery can be equipped with five conductive glides or five ESD casters. Can be also equipped with KT type ESD armrests, footrest and enlarged gaslift on request.

- Back angle adjustments
- Seat height adjustment: 43-63 cm



VKG C-310 ESD



**ESD** laboratory chair with conductive incombustible polyurethane upholstery can be equipped with five conductive glides or five ESD casters. Can be also equipped with footrest and enlarged gaslift on request.

- Back angle adjustments
- Seat height adjustment: 43-63 cm



VKG C-320 ESD



**ESD** laboratory chair with conductive incombustible polyurethane upholstery can be equipped with five conductive glides or five ESD casters. Can be also equipped with KT-2 type ESD armrests, footrest and enlarged gaslift on request.

- Back angle adjustments
- Seat height adjustment: 43-63 cm



VKG C-330 ESD



**ESD** laboratory chair with conductive incombustible polyurethane upholstery can be equipped with five conductive glides or five ESD casters. Can be also equipped with KT-2 type ESD armrests, footrest and enlarged gaslift on request.

- Back and seat angles adjustments
- Seat height adjustment: 43-63 cm



1 VKG C-400 ESD



ESD laboratory stool with conductive incombustible polyurethane upholstery can be equipped with five conductive glides or five ESD casters. Can be also equipped with ESD footrest and enlarged gaslift on request.

- Seat height adjustment: 43–63 cm
- Resistance: less than 1 MOhm
- Weight: 4 kg
- Cleanroom — suitable



2 VKG C-410 ESD



KT-2 ESD armrests



A set of ESD armrests can be additionally ordered for VKG C-320, C-330 types of ESD chairs.

KT ESD armrests for VKG series



A set of ESD armrests can be additionally ordered for VKG C-100, C-200, C-300 types of ESD chairs.

VKG F-05 ESD glides for all chairs



A set of five ESD glides may be ordered for all types of ESD chairs and ESD stool.

KT ESD armrests for VKG series



ESD chairs and armchairs are originally equipped with KJ/200 gaslift, which allows to adjust seat height 43–63 cm from the floor. KJ/200 and KJ/260 gaslifts can be also ordered separately.

P607A ESD casters for all chairs



A set of five black ESD casters may be ordered for all types of ESD chairs and ESD stool.

Seat height adjustment

- KJ/200 — 43–63 cm
- KJ/260 — 54–83 cm

L607 A casters for all chairs



A set of five light-grey smudge free ESD casters may be ordered for all types of ESD chairs and ESD stool.

Foot ring (support) for VKG series

Height-adjustable supportive foot ring. Recommended for chairs with extended gaslifts.

Ring diameter

- JR-430 — 43 cm
- JR-600 — 60 cm



STREAM 280-SY



- 5 Cm cold-foam seat and 3.5 Cm cold-foam backrest
- Seat height adjustment : 43 cm –54 cm
- Available in 2 colors (black and grey)
- Extra strong aluminum 5-star base provides 120 kg load capacity
- Available in both esd and technical versions

**STREAM 280-SY ESD Armchair** is designed especially for workplaces where antistatic environment is required. It also provides individually adjustable ergonomic sitting.

5 years warranty guaranteed.

Can be equipped with ESD glides, ESD casters, armrests, higher gaslift with foot ring.

For safety reasons a model equipped with higher gaslift and foot ring available only with glides.

**GS CERTIFICATE**

fulfills standards:

- DIN EN 1335-1:2002-08 + B1:2002-11
- DIN EN 1335-2:2010-01
- DIN EN 1335-3:2009-08
- DIN EN 13761:2002-12

**ERGONOMIC CERTIFICATE**

fulfills the standard:

- DIN EN ISO 9241-5:1999-088

**TOX FREE CERTIFICATE**

polutant free:

- Cadmium
- Formaldehyd
- PAK
- Azodyes

Accessories for STREAM 280-SY

BR-207-1-CHR



- Height-adjustable** black nylon armrests, polypropylene arm pads.
- BR-AL-CHR-ESD — conductive type
  - BR-207-1-CHR — insulating type

BR-AL-CHR-ESD



- Aluminum** armrests with fixed shape and height.

KJ/650-CHR



- Set of higher gaslift with foot ring
- Can be equipped with esd glides only
- Seat height 65–93 cm

R-SK Changing room bench



**R-SK** Changing room benches are simple and cost-effective solution for changing rooms and dressing rooms, supplied in technical and ESD versions.

**Changing** room benches feature reinforced robust construction and can be height adjusted.



455 - 735 mm from floor level



of the seat 1500x400 mm



up to 400 kg



# VKG TOOLS ANTISTATIC EQUIPMENT

## VKG A-2000 TURNSTILE ACCESS CONTROL SYSTEM TO ESD PROTECTED AREA



- 1 — antistatic coating
- 2 — restrictive strip
- 3 — shoe cleaning mat
- 4 — plates for checking shoes
- 5 — access indicator
- 6 — front panel of the tester with built-in access card reader
- 7 — turnstile

### Technical specifications

MODEL	VKG A-2000
Max quantity of identity cards in the system, pcs	5000
Time for wrist straps and shoes testing, sec	2
Direction of entry	both directions
Wrist strap control on/off mode*	included
Identity cards type	EmMarine
Data exchange interface	RS-485
Wrist strap connector types	<ul style="list-style-type: none"> <li>- 15 mm button</li> <li>- 3273-I-J jack</li> </ul>
Operating conditions	
Temperature, °C	15 to 35 °C
Relative humidity at 30 °C	less than 75%
Max. power consumption	220 ± 20
Dimensions, mm	280 × 990 × 1110
Dimensions with testing plate, mm	280 × 990 × 1545
W 3273-I-J jack eight, kg	50 кг

\*switched by a toggle switch in the electronics compartment or using VKG TOOLS Access Manager software.

VKG A-2000 EPA access control system produced on a basis of a three-bar automatic turnstile.

VKG A-2000 access control system consists of an automatic turnstile, a built-in testing device, an access cards reader, an ESD shoes testing plate and a software that provides an operational check of ESD shoes and wrist straps for ESD standards compliance.

VKG A-2000 system ensures that only employees with appropriate & functional personnel grounding are allowed to enter the EPA.

Once the employee's card has been identified and the wrist strap and shoes test has been successfully completed, the employee is given access to the EPA. If the test fails, access to the ESD area is not provided.

### VKG TOOLS ACCESS MANAGER SOFTWARE

The VKG TOOLS Access Manager software allows to flexibly configure employee access levels and generate reports.

The software includes two levels:

**- VKG TOOLS Access Manager**

Administrator allows you to add / remove employees, assign and program access levels, generates reports

**- VKG TOOLS Access Manager**

Operator monitors in real time the information about employees entries through the A-2000 system, generates reports

VKG A-2000 turnstile access control system to ESD Protected Area supplied in a set:

- A-2000 EPA Access Control turnstile with ESD shoes testing plate
- Operation manual
- USB-stick with VKG TOOLS Access Manager software.

Additionally supplied:

- control panel for turnstile remote unlocking
- EmMarine format access cards



# GROUNDING EQUIPMENT

VKG G-01 Universal grounding unit



**Universal** grounding unit compatible with most popular wrist strap connections :  
 banana plug, GSGS, 4, 4.5, 7 and 10 mm snaps.  
 - Grounds up to two single wrist straps  
 - 3 meter cord with eyelet  
 - No resistor  
**Should** be mounted underneath tabletop and devices via junction block.

VKG A-9400 Connecting plug for grounding cables



**White** connecting plug for grounding cables with 1 MOhm resistor.

VKG A-3146 Grounding unit



**Two** 10 mm buttons ground wrist straps and devices via junction block.

Wrist strap coil cords



**1 MΩ** resistor (Wrist strap connection side). Types of connections to fit most grounding systems worldwide. Female stud connections. Black color. Suitable to connect to a ground via VKG G-1

CODE	DESIGNATION	CORD LENGTH
30-560-0604	6' COIL CORD 4 mm / banana + crocodile clip	1.80 m
30-560-1004	12' COIL CORD 4 mm / banana + crocodile clip	3.00 m
30-560-0641	6' COIL CORD 4 mm / 10mm	1.80 m
30-560-0614	6' COIL CORD 4 mm / GSGS	1.80 m
30-560-0645	6' COIL CORD 4 mm / 4.5 mm	1.80 m
30-560-1014	10' COIL CORD 4 mm / GSGS	3.00 m

VKG KH 4060, VKG KH 6090, VKG KH 12060 ESD mats



Fire-resistant and solder-resistant ESD mats.

Supplied in a set with grounding cord.

- Antiglare matte surface
- Colors: blue, grey

CODE →	VKG KH 4060	VKG KH 6090	VKG KH 12060
Dimensions	400×600 mm	600×900 mm	1200×600 mm
Charge decay time	Less than 0.04 sec		
Typical resistance to ground	10 <sup>5</sup> ...10 <sup>9</sup> Ohm		

Antistatic Floor Mat TOROSTAT

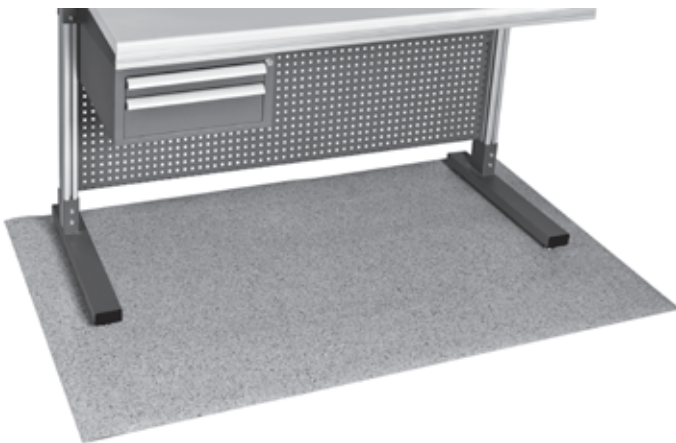

Double-layer anti-static floor mat 2.5 mm thick, abrasion resistant, sound-absorbing, non-flammable, thermally stable, dissipative top layer and conductive bottom layer: dripping time charge from 1000 V to 50 V in less than 0.5 seconds, the resistance of the ground — less than 100 MΩ, the combined resistance — less than 35 MΩ. Various dimensions: 150 mm×200 to 1000×10000 mm.

ESD Wrist straps



**VKG A-2202** conductive fabric wrist strap with 4 mm button and a 4 mm to 10 mm buttons cord

**VKG A-2202-0** conductive fabric wrist strap with 4 mm button

**VKG A-2210** conductive metal wrist strap with 4 mm button and a 4 mm to 10 mm buttons cord

**VKG A-2210-0** conductive metal wrist strap with 4 mm button

# PUREX FUME EXTRACTION SYSTEMS



The soldering process itself can produce some harmful fumes. These fumes can cause occupational asthma, long-term carcinogenic diseases and other serious complaints. The result of these illnesses can be expensive compensation claims from employees, long-term sickness and poor employee relations, plus heavy penalties from enforcement agencies.

Purex fume extraction systems are designed in conjunction with some of the world's largest Contract Electronics Manufacturers and Equipment Providers to help:

- Prevent damage to production machinery.
- Reduce downtime for cleaning and maintenance.
- Protect personnel from harmful fumes.
- Reduce product rejects due to poor production performance.
- Maintain a constant extraction rate to ensure stable temperature profiles.
- Deliver long filter life.
- Interface with the production equipment.

Fume Cube line units are used for:

- Soldering assembly
- Gluing and chemical treatments
- Laboratory/cleanroom tasks
- Rework and repair

The FumeCubeLITE is a low cost, portable system for one or two users, Fume Cube and Fume Cube 2 are more sophisticated and functional arm extraction and purification systems, which are used to protect personnel from hazardous particles and fumes.

System Features:

- Precision made from stainless steel
- Low capital and running costs
- Quick change pre-filters deliver longer filter life
- Submicronic (HEPA) filtration removes 99.997% of particles down to 0.3 microns
- Activated carbon filtration removes harmful gas
- Simple to install and quiet in operation
- Easy to relocate
- Optional interfacing option



TECHNICAL FEATURES	
Voltage (V)	230 (120)
Frequency (Hz)	50/60
Wattage (kW)	0.14 (0.107)
ON/OFF switch	On rear
Power cable	2 m
Noise intensity, dBA	60
Dimensions (mm):	308×294×366



1



2



3

	FUMECUBE <sup>LITE</sup>	FUMECUBE	FUMECUBE 2
Picture number	1	2	3
Code	072100	072066	072065
Number of arms	1 or 2	1	2
Filters pre-installed	Pre filter pad	Pre filter pad + main HEPA/Chemical filter	
Warning system	—	VariColour filter blocked warning system	
Airflow	Fixed airflow — 190m <sup>3</sup> /hr in free air	Automatic flow control and speed control (adjustable airflow)	
Arm kit	One or 2 pieces of 100294, 100295 or 100295 ESD kits should be ordered separately		

100294 Kit



Optional accessories

100295 Kit

TYPE OF ACCESSORIES	ORDERING CODE
Remote ON/OFF switch	TBA
FLEXIBLE ARM KIT with Screw Bracket without Conical cowl and Pen-nib nozzle	100294
FLEXIBLE ARM KIT with Clamp Bracket	100295
FLEXIBLE ARM KIT- ESD Version with Clamp Bracket	100295 ESD
Cleanroom filters	110538
Chemical filters	110537
Double chemical filters	110536



Wide range of fume extractors for laser engraving, tip extractions, reflow or wave soldering up to 36 arms, 50 iron tips and over 3000 m<sup>3</sup>/hr is available. Ask us for more details.

## ESD STORAGE AND PACKAGING

### STANDARDIZED ESD TRAYS FOR BOARDS AND COMPONENTS STORAGE

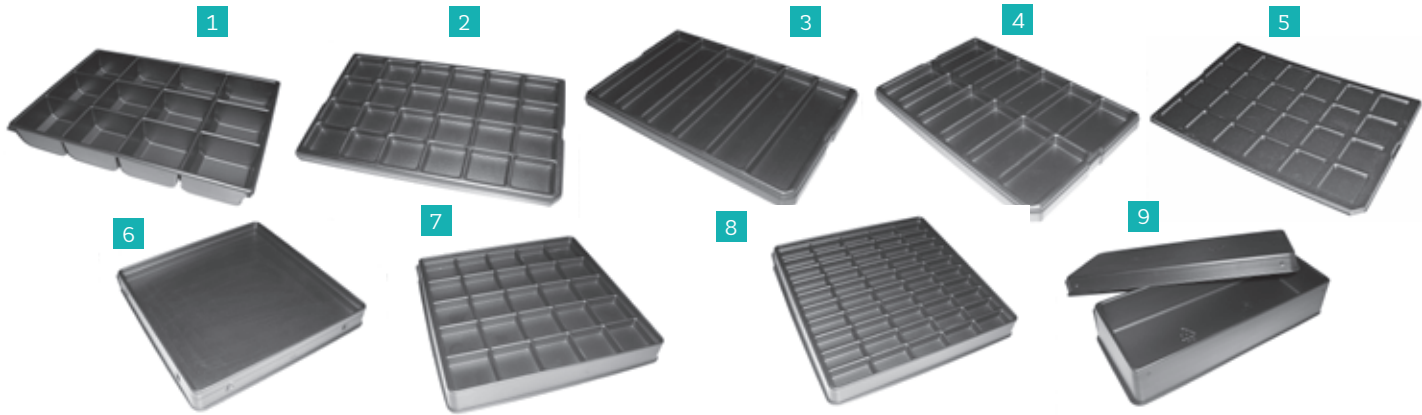

Nº	CODE	DIMENSIONS	DIMENSIONS OF EACH CELL	THICKNESS	NUMBER OF CELLS
1	24-204-0650	330×250×50 mm	66×56	3,0 mm	12
2	24-204-1486	350×225×20 mm	44,57×46,86	3,0 mm	24
3	24-204-2273	350×225×20 mm	48×208	3,0 mm	6
4	24-204-2531	350×225×20 mm	97,2×45,9	3,0 mm	12
5	24-204-2532	350×225×5 mm	Cover*	1,2 mm	24
6	24-204-2533	210×210×24 mm	192×192	1,2 mm	1
7	24-204-2819	210×210×24 mm	36×36	0,8 mm	25
8	24-204-2820	210×210×24 mm	36×15	0,8 mm	50
9	24-204-2821	295×120×60 mm	100×275	1,5 mm	1

ESD trays are used for storage, transport and packaging of boards, components and finished units of electronic assembly. Made of conductive carbon-loaded PS —dissipative material resistance  $\leq 10^4 \Omega$ . Color — black.

\* Cover for trays 24-204-2273, 24-204-2274, 24-204-2531, 24-204-2532

MOQ 100 pieces

## DESKTOP STORAGE SYSTEMS

NPP Desktop swivel plate

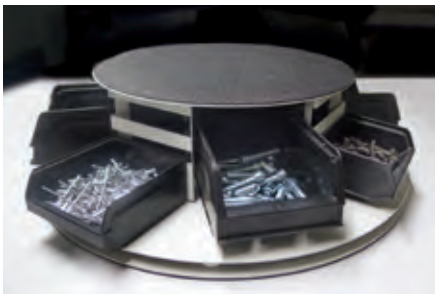

The modular system allows to combine several types of tabletop turntables for electronics assembly works. NPP modular desktop swivel system combines several types of tabletop turntables to simplify various works in electronics assembly.

The system produced in 2 sizes:

- with a 450 mm rotating base
- with a 550 mm rotating base



**NPP-45** — a 450 mm rotary platform-base. Height — 18 mm



**NPP/P-45** — a 450 mm diameter two-level turntable platform with an upper plate, it can be additionally equipped with 4 Cocis A type bins and 4 Cocis B type bins. Height — 100 mm

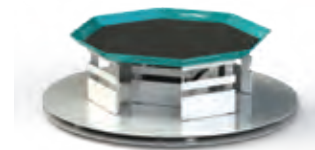

**NPP/L-45** — a 450 mm diameter two-level turntable platform with an upper tray, it can be additionally equipped with 4 Cocis A type bins and 4 Cocis B type bins. Height - 109 mm



**NPP-55** — a 550 mm rotary platform-base. Height — 18 mm



**NPP/P-55** — a 550 mm diameter two-level turntable platform with an upper plate, it can be additionally equipped with 6 Cocis A type bins and 6 Cocis B type bins. Height - 100 mm

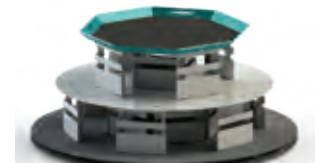

**NPP/L-55** — a 550 mm diameter rotary three-level turntable platform with an upper tray, it can be additionally equipped with 10 Cocis A type bins and 10 Cocis B type bins. Height 196 mm

**! Plastic ESD bins for the system shall be ordered separately**

## ANTISTATIC STORAGE

### COCIS antistatic bins



**Conductive** ESD bins are used for small components and tools storage. Made of antistatic polypropylene. Can be easily attached to bin rails or fitted for free standing on a grounded surface. Bins of equal width can be stacked on one another.

CODE	OUTER DIMENSIONS	INNER DIMENSIONS
COCIS-A	107 × 98 × 47 mm	92 × 83 × 42 mm
COCIS-B	170 × 105×75 mm	130 × 93 × 68 mm
COCIS-C	250 ×150 × 130 mm	185 × 135 × 122 mm
COCIS-E	350 × 230 × 150 mm	265 × 206 × 140 mm

### Conductive Polypropylene Containers

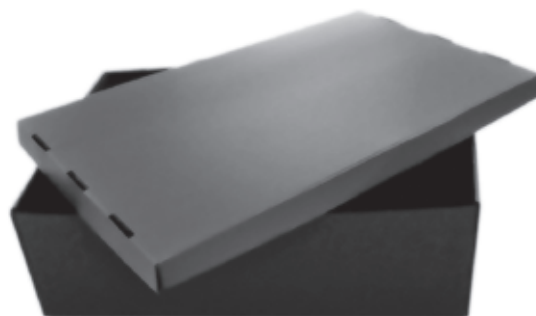

- Thickness — 2.5 mm
- Delivered unassembled
- Apertures for easy carrying on each side

CODE - BOX	CODE - LID	OUTER DIMENSIONS (MM)
23-175-7108	23-175-7110	400 × 300 × 180
23-175-7109	23-175-7110	400 × 300 × 228
23-175-7104	23-175-7106	600 × 400 × 180
23-175-7105	23-175-7106	600 × 400 × 228

### Modular ESD trays

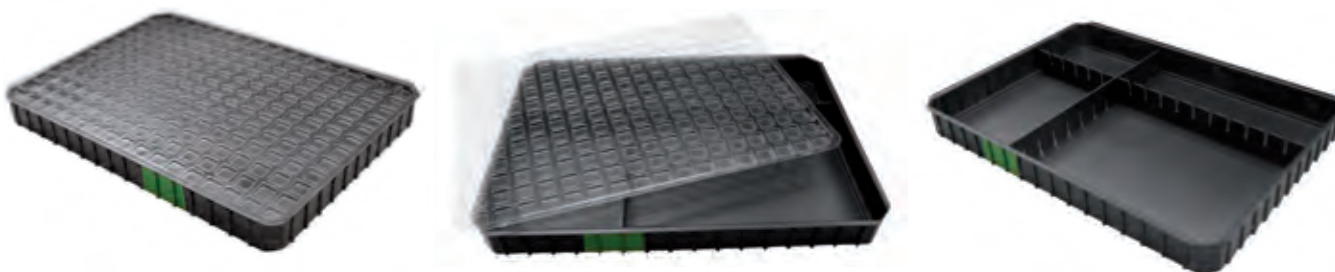

**Standard** range of trays with a set of modular dividers. This new item will reply to various need for convenient storing and transporting small PCB's on sensitive components.

**Stackable** tray for components storage with transparent lid and removable dividers that should be ordered separately. Lid and dividers are clipped on the tray.

The system with dividers provides the possibility to organize 2 to 204 cells for components storage. Minimum size of the cell is 15×15 mm

TYPE OF UNIT	ESD TRAY FOR PCB'S	TRANSPARENT LID FOR THE TRAY	SHORT DIVIDERS (11 NOTCHES)	LONG DIVIDERS (15 NOTCHES)
Code	24-401-9428	24-213-9429	23-177-9431	23-177-9430
Material	Dissipative PS	Clear APET	Conductive PS	Conductive PS
Thickness, mm	1.5	0.8	1.8	1.8
Dimensions, mm	355×255×36	355×255×5	247×2×30	347×2×30

**Useful** height of the tray with lid — 28 mm

## ESD MAGAZINES



- Vertical pitch 10 mm
- Width adjustable by 5 mm pitch
- Strong construction from thermoformed plastic with metal reinforcement
- Light in weight and extremely rigid
- Assembled using rivets and ultrasonic welding
- Each groove is numbered
- Each magazine is delivered with a partition

2 versions available:

- PS for a 60°C heat resistance
- ABS/PC for 110°C heat resistance

### PS magazines

Extra partitions and lids available on request.

CODE	DIMENSIONS	PCB	CODES FOR ADJUSTABLE PLATES
22-150-0943	320×350×560	247	97-001-0003
22-150-1154	370×370×560	297	97-001-0003
22-150-1187	400×425×560	327	97-001-0001
22-150-0817	420×460×560	357	97-001-0001
22-150-0891	450×425×560	377	97-001-0007
22-150-1083	470×480×560	397	97-001-0007

### ABS/PC magazines

Extra partitions and lids available on request.

CODE	DIMENSIONS	PCB	CODES FOR ADJUSTABLE PLATES
22-151-0943	320×350×560	247	97-011-0005
22-151-1154	370×370×560	297	97-011-0005
22-151-1187	400×425×560	327	97-011-0001
22-151-0817	420×460×560	357	97-011-0001
22-151-0891	450×425×560	377	97-011-0003
22-151-1083	470×480×560	397	97-011-0003



### Quickfill Magazine

Quickfill magazines meet standard dimensions most frequently used on automated lines. Strong injection molded construction with metal reinforcement (top and bottom). Standardized plate that fits most popular brands on the market.

- Not subject to accidental change in width; no wear of moving parts
- Partition made of assembled plastic parts
- This system provides a better dimensional stability when strong temperature variations
- Meant for 50 PCB's

**Material:** Conductive PS (60°C heat resistance) or ABS/PC (110°C heat resistance) for plastic parts, galvanized Iron for metal parts.

CODE	DIMENSIONS	MATERIAL VERSION	MIN./MAX. PCB SIZE
22-152-3060	460×400×563	PS	50/300
22-152-4060	355×320×563		50/250
22-152-6060	460×400×563		100/310
22-152-7060	535×460×570		50/390
22-152-8060	535×530×570		120/460
22-152-1120	460×400×563	ABS/PC	50/300
22-152-2120	355×320×563		50/250
22-152-3020	535×460×570		50/390



# CATALOG LEGEND



Dimensions of the product/module



Usable area of the product/module.  
Only refers to non-adjustable dimensions.



Link to additional information about the product



Load capacity of the product/module



Weight of the product/module



Possible height adjustment of the working surface



Depth of the product/module



Maximum impermanent temperature impact



The product/module is available in ESD version



The product/module is available in Technical version



The product/module is available in dark grey  
RAL 7012 color



The product/module is available in light grey  
RAL 7035 color



The product/module is bicolored by default and available in combination of dark grey RAL 7012 and light grey RAL 7035 colors



The product/module is bicolored by default and available in combination of light grey RAL 7035 and turquoise RAL 5021 colors



The product/module is multicolored by default and available in combination of black RAL 9005, white RAL 9010 and turquoise RAL 5021 colors



The product/module is available in black RAL 9005



The product/module is available in white RAL 9010



The product is cleanroom suitable

TECHNICAL & ESD FURNITURE  
ANTISTATIC EQUIPMENT  
DRY STORAGE CABINETS

**VIKING**



Authorised Regional Agent:

**BURNDALE TECHNOLOGIES (PTY) LTD**

Block A, Wedgefield Office Park

17 Muswell Road, South Bryanston

Gauteng, 2021

South Africa

[info@burndaletech.co.za](mailto:info@burndaletech.co.za)



**BURNDALE TECHNOLOGIES**